

SONY.

3-752-932-21(1)

Color Rear Video Projector

KPR-53CX35

KPR-53EX35

KPR-46CX35

KPR-46EX35

Operating Instructions

Before operating your projection TV, please read this manual thoroughly and retain it for future reference.

Owner's Record

The model and serial numbers are located at the rear of the projection TV. Record these numbers in the spaces provided below. Refer to them whenever you call upon your Sony dealer regarding this product.

Model No. KPR-

Serial No. _____

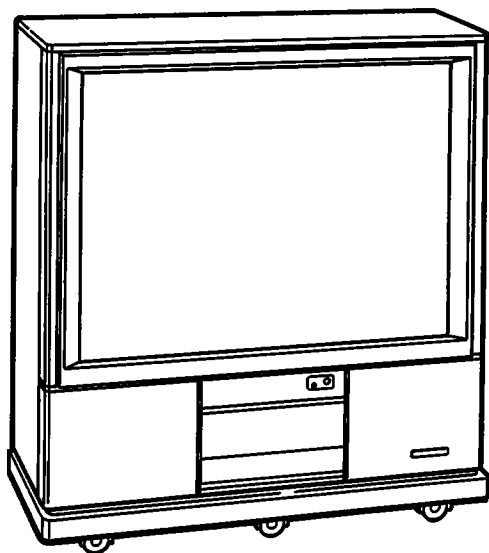

Contents

Preface

This section tells you about special features, safety information, and preparatory information for using this manual.

Chapter 1 : Set up

This section shows you the steps for installing and presetting your projection TV.

Chapter 2 : Basic Operation

This section gives you basic information about using your projection TV.

Chapter 3 : Advanced Operation

This section shows you how to use Picture-in-Picture and other useful features, as well as the Programmable Remote Commander.

Chapter 4 : Other Connections

This section shows you how to connect optional video and audio equipment to your projection TV.



Appendix

This section gives you the viewing area, specifications and troubleshooting information.

- For a detailed table of contents, see page 3.

WARNING

To prevent fire or shock hazard, do not expose the unit to rain or moisture.

	CAUTION RISK OF ELECTRIC SHOCK DO NOT OPEN	
<p>CAUTION : TO REDUCE THE RISK OF ELECTRIC SHOCK, DO NOT REMOVE COVER (OR BACK). NO USER-SERVICEABLE PARTS INSIDE. REFER SERVICING TO QUALIFIED SERVICE PERSONNEL.</p>		



This symbol is intended to alert the user to the presence of uninsulated "dangerous voltage" within the product's enclosure that may be of sufficient magnitude to constitute a risk of electric shock to persons.



This symbol is intended to alert the user to the presence of important operating and maintenance (servicing) instructions in the literature accompanying the appliance.

CAUTION:

TO PREVENT ELECTRIC SHOCK, DO NOT USE THIS POLARIZED AC PLUG WITH AN EXTENSION CORD, RECEPTACLE OR OTHER OUTLET UNLESS THE BLADES CAN BE FULLY INSERTED TO PREVENT BLADE EXPOSURE.

Note to CATV system installer

This reminder is provided to call the CATV system installer's attention to Article 820-22 of the NEC that provides guidelines for proper grounding and, in particular, specifies that the cable ground shall be connected to the grounding system of the building, as close to the point of cable entry as practical.

Use of this color rear video projector for other than private performance of programs broadcast for the use of the general public may require authorization from the transmitter and/or owner of such programs. Use with cable television transmission may require authorization from the cable system transmitter and/or program owner.

Table of Contents

Preface	
WARNING	2
Introducing the Sony 46/53 KPR Series	4
Features	5
Precautions	6
Mounting the Mirror Cover (KPR-53CX35 and KPR53EX35)	7
Location of Controls	8

Chapter 1: Set up	
Preparing the Remote Commanders	10
Connecting TV Antenna/Cable	11
Adjusting Color Registration	13
Presetting TV Channels	14

Chapter 2: Basic Operation	
Watching TV Programs	16
Adjusting Picture and Sound Quality	18

Chapter 3: Advanced Operation	
Using Picture-in-Picture	20
Enjoying Other Useful Features	28
Using the Programmable Remote Commander	30
Operating Non-Sony or Sony Video Equipment (Pre-Programmed Function)	31
Operating Audio and Video Equipment (Learning Function)	32

Chapter 4: Other Connections	
Using Optional Equipment	34
Connecting Video Equipment	35
Connecting Audio Equipment	38

Appendix	
Viewing Area	39
Specifications	40
Troubleshooting	41

Introducing the Sony 46/53 KPR Series

This manual covers four models, KPR-53CX35, KPR-53EX35, KPR-46CX35 and KPR-46EX35. The only differences among them are screen size, and cabinet design and dimension. All the functions are exactly the same. The illustrations in this manual are based on model KPR-53CX35. This model is equipped with a special acrylic plastic filter "third screen" which protects the two main screens, and gives the overall screen surface a deep, glossy appearance.

Design

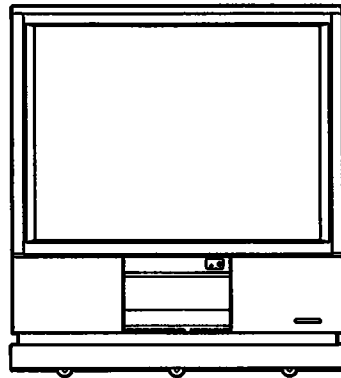

KPR-53CX35

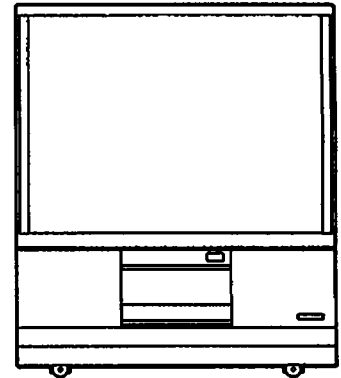

KPR-53EX35

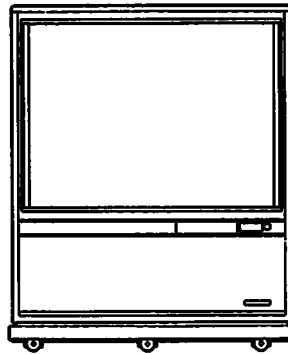

KPR-46CX35

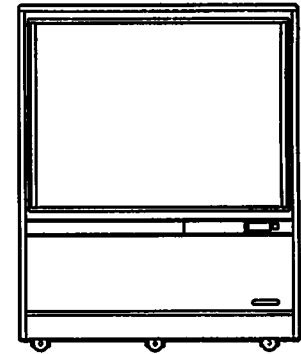

KPR-46EX35

Supplied
Remote
Commander

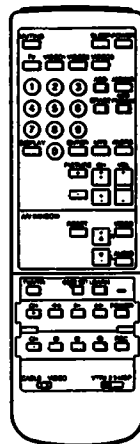

and

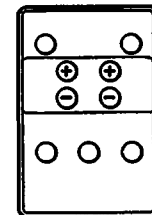

Features

Standard, as with most recent Sony TVs:

- **Multiband VHF/UHF/CATV tuner** receives up to 125 cable channels for a total of 181 possible off-air and cable channels.
- **Built-in MTS (Multichannel TV Sound) decoder** lets you receive stereo programs and Second Audio Program (SAP) broadcasts.
- **S VIDEO INPUT jack**, when connected to the S video output jack on the VCR, allows superior quality pictures from the VCR to be displayed on the screen.
- **Built-in video and L/R audio line output jacks** provide selected output from the TV tuner or any equipment connected to the audio/video line inputs.
- **On-screen displays** clearly show the current operating modes and adjustments being made.

Unique to the KPR series:

- **New Dynamic picture™ system** automatically adjusts picture contrast to produce more detail in both bright and dark areas of every scene.
- **VM (Velocity Modulation) circuit** produces clean, sharp black and white contrasts.
- **Dynamic Focus™ circuit** automatically focuses the scanning electron beam for enhanced sharpness over the entire picture, especially in the corners.
- **Liquid cooled optically coupled picture tubes** with new coolant formulation and pressure release diaphragm generate super-bright images without heat build-up.
- **Shading compensation circuit** assures proper color balance across the entire screen.
- **High voltage regulator** maintains consistent image size and prevents "zooming" in and out of focus during sudden changes between dark and light scenes.
- **Hybrid lenses:** a multi-element combination of top-quality coated glass lenses and spherical acrylic lenses for the best light-transiting and focusing characteristics of both materials.
- **Multi-layer lens coating** increases brightness and improves contrast ratio by reflecting light beams forward again and again.

- Improved blue phosphor helps maintain long-lasting pure, clean whites.
- Improved green phosphor minimizes "burn-in" effect of still images on your VideoScope screen, doubling the long-term luminescence of your system.

The supplied remote commanders provide you with the following and other convenient features.

- **With the programmable remote commander**, you can operate video equipment, multi disc player equipment made by Sony or other manufacturers, and remote controlled decoder box for watching pay cable TV, as well as the projection TV.
- **Picture-in-Picture feature** lets you watch more than one channel at once. A TV channel or video source can be displayed in a window picture, set into the corner of the main screen.
- **Sound Retrieval System (SRS®)*** enhances both stereo and monaural sound.
- **Sleep timer** automatically turns off the projection TV after approximately one hour.
- **Automatic programming** presets all receivable channels instantly.
- **ANT/AUX button** controls one-touch selection of pay cable TV when a converter is connected.
- * *Sound Retrieval System (SRS®) reproduces the ambience and dynamics of a live performance, creating the sense of being present at the concert hall or recording studio. SRS lets you enjoy optimum sound from anywhere in the room.*

(●) SOUND RETRIEVAL SYSTEM

The (●) Sound Retrieval System is manufactured by Sony Corporation under license from the Hughes Aircraft Company, a subsidiary of GM Hughes Electronics. It is covered by U.S. Patent No. 4,748,669. Other U.S. and foreign patents pending.

(●), Sound Retrieval System and SRS® are trademarks of the Hughes Aircraft Company, a subsidiary of GM Hughes Electronics.

Precautions

Safety

- Operate the projection TV only on 120 V AC.
- Should any liquid or solid object fall into the cabinet, unplug the projection TV and have it checked by qualified personnel before operating it any further.
- Unplug the projection TV from the wall outlet if you are not going to use it for several days or more. To disconnect the cord, pull it out by the plug. Never pull the cord itself.

Installation

- To prevent internal heat build-up, do not block the ventilation openings.
- Do not install the projection TV in a hot or humid place, or in a place subject to direct sunlight, excessive dust or mechanical vibration.
- Avoid operating the projection TV at temperatures below 41°F (5°C).
- After transporting the projection TV directly from a cold to a warm location, or if the room temperature has changed suddenly, pictures may be blurred or show poor color over portions of the picture. This is because moisture has condensed on the mirrors or lenses inside the projection TV. Let the moisture evaporate before using the projection TV.
- Avoid placing the projection TV on a slanted or uneven floor.

Illumination

To obtain a clear picture, the screen should not be directly exposed to illumination or sunlight. If possible, use spot lighting directed down from the ceiling.

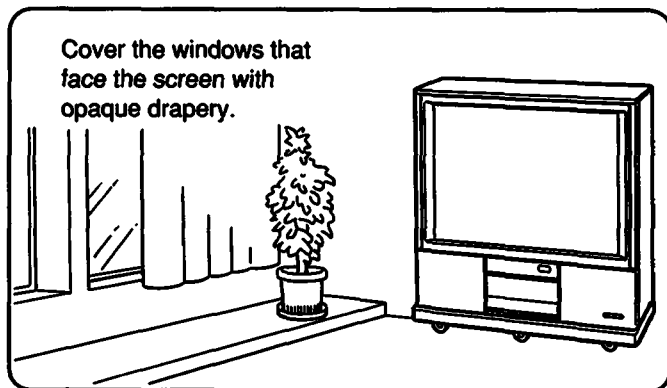

The floor and walls should not be of a light-reflecting material. If necessary, cover them with dark carpeting or wallpaper.

Maintenance

- Save the original shipping carton and packing material to use if you ever have to ship your projection TV. For maximum protection, repack your projection TV as it was originally packed at the factory.
- To keep the cabinet looking brand-new, periodically clean it with a soft cloth. Stubborn stains may be removed with a cloth slightly dampened with a mild detergent solution. Never use strong solvents such as thinner or benzine, or abrasive cleansers since these will damage the cabinet. As a safety precaution, unplug the projection TV before cleaning it.
- To remove dust from the front of the screen, unplug the projection TV and wipe it gently with a soft cloth slightly dampened with water or a mild detergent solution, using vertical strokes only. Then wipe it again with a dry, soft cloth. Never use solvents or thinners for cleaning purposes.
- If the picture turns dark after the projection TV has been in use for a long period of time, it may be necessary to clean the inside of the projection TV. Consult qualified service personnel for this.
- Do not keep the still picture displayed long (FREEZE - p. 25). It may cause a phosphor mark on the screen.

Mounting the Mirror Cover (KPR-53CX35 and KPR-53EX35)

The mirror cover is turned over and installed inside the cabinet for transporting. If you have one of the above models, please remount the mirror cover as follows.

Notes

- Before mounting, turn off the power and unplug the power cord from the AC wall outlet.
- Handle the mirror cover with care as the mirror is mounted inside.
- Do not touch the mirror surface or any parts inside the cabinet.
- Do not use the handles to carry or transport the set. The handles are designed only for turning the mirror cover over.

1 Remove the nine black screws.

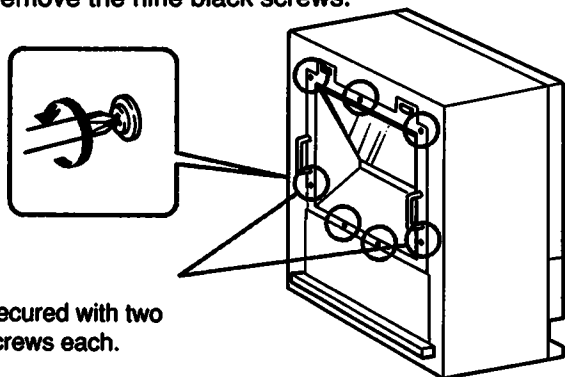

2 Slide the mirror cover up and out from the latches.

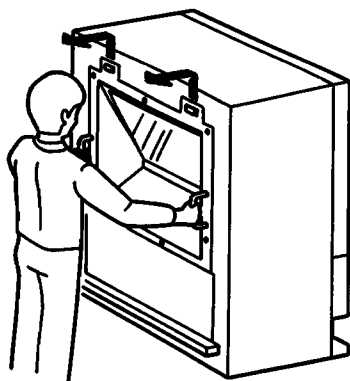

3 Turn the mirror cover over.

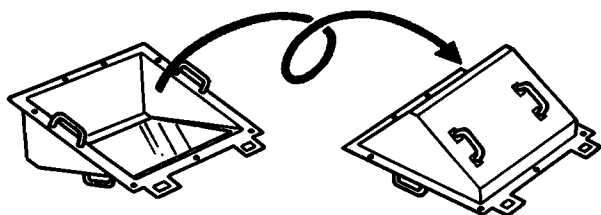

4 Hold the mirror cover by its handles and remount it.

Be sure to hook the mirror cover on both latches.

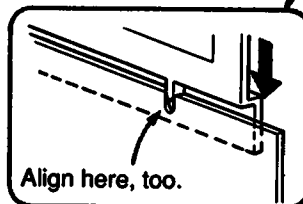
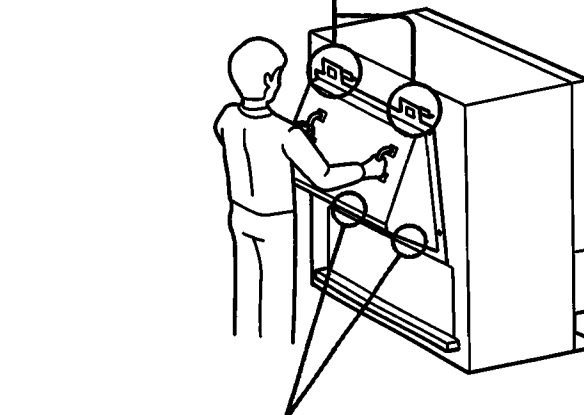
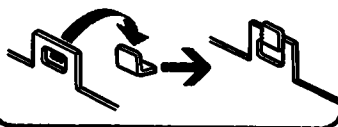

5 Secure the mirror cover by replacing the nine black screws to where you removed them from in step 1.

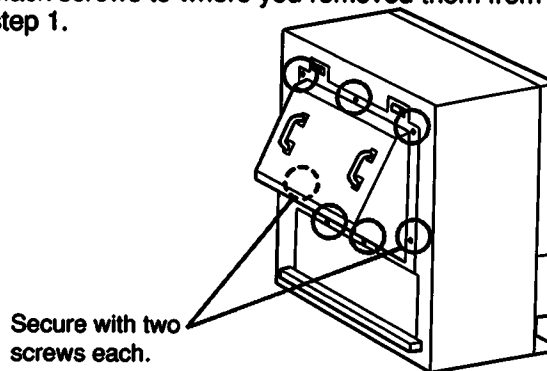

Location of Controls

For details, refer to the pages indicated by the numbered black circles ●.

Front

Displays for Picture/Sound Quality adjustment feature ● ●

- **Current level/Item selection display**
Displays the qualities (COLOR, HUE, TREBLE, BASS, etc.) for selection, and their current settings.
- **Item display**
Displays the quality selected for adjustment with the A/V WINDOW buttons, and RESET indication.
- **Adjustment level display**
Displays the level as you make the adjustment.

Sound Retrieval System display ●

● SRS (STEREO)/(MONO)/OFF

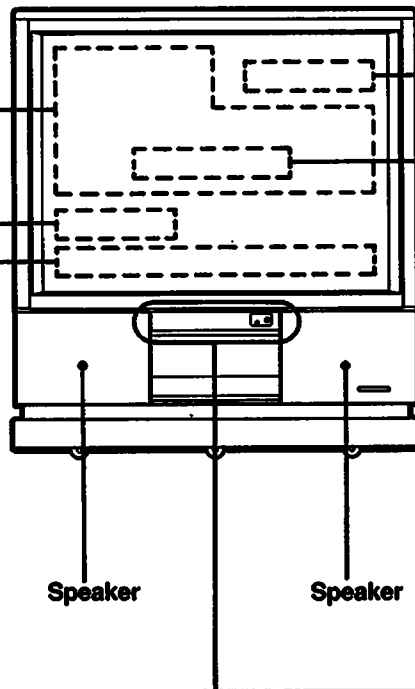

Display for:

- Channel numbers/Cable "C" display
- MTS mode (MAIN, SAP or BOTH)
- Selected input sources (VIDEO 1, VIDEO 2 or VIDEO 3)
- AUX, MUTING or SLEEP indication

AUTO PROGRAM display ●

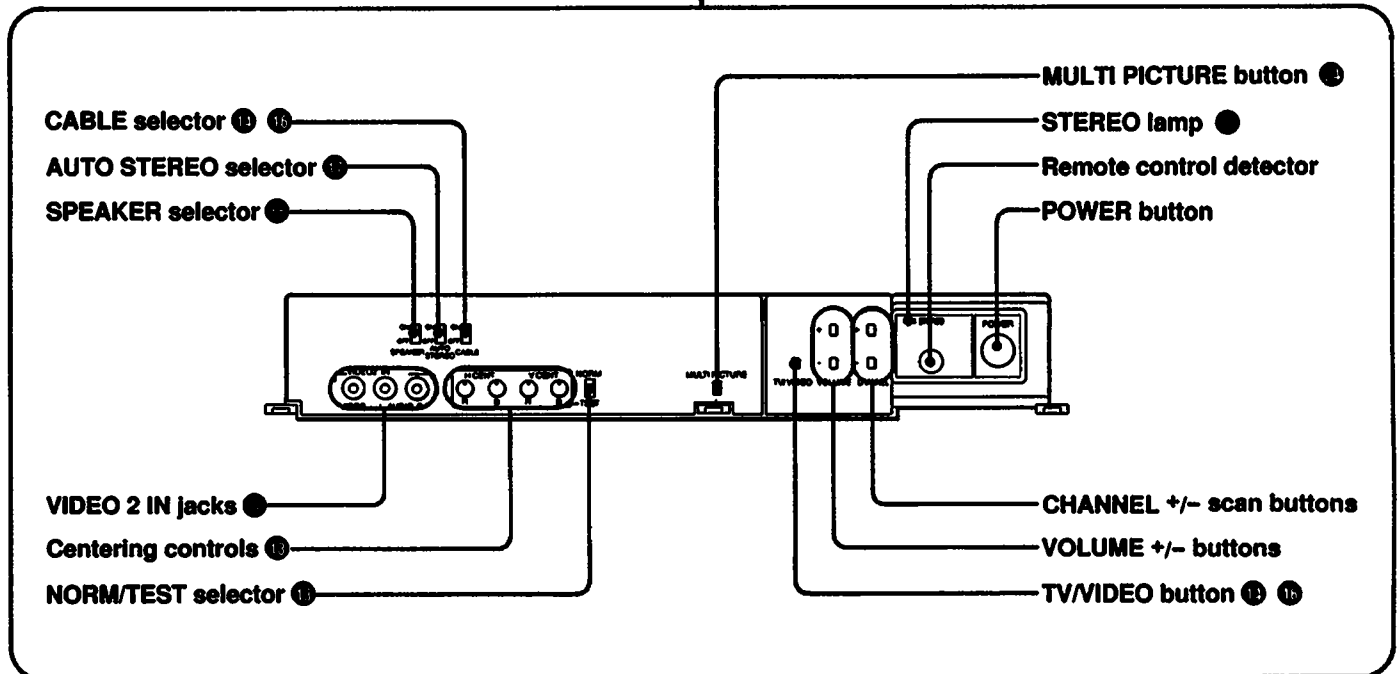

- **CABLE selector** ● ●
- **AUTO STEREO selector** ●
- **SPEAKER selector** ●

MULTI PICTURE button ●

STEREO lamp ●

Remote control detector

POWER button

VIDEO 2 IN jacks ●

Centering controls ●

NORM/TEST selector ●

CHANNEL +/- scan buttons

VOLUME +/- buttons

TV/VIDEO button ● ●

Programmable Remote Commander RM-Y110

Note

Most of the functions require the Programmable Remote Commander.
Please do not lose it.

* The same function buttons are also located on the projection TV (p. 8).

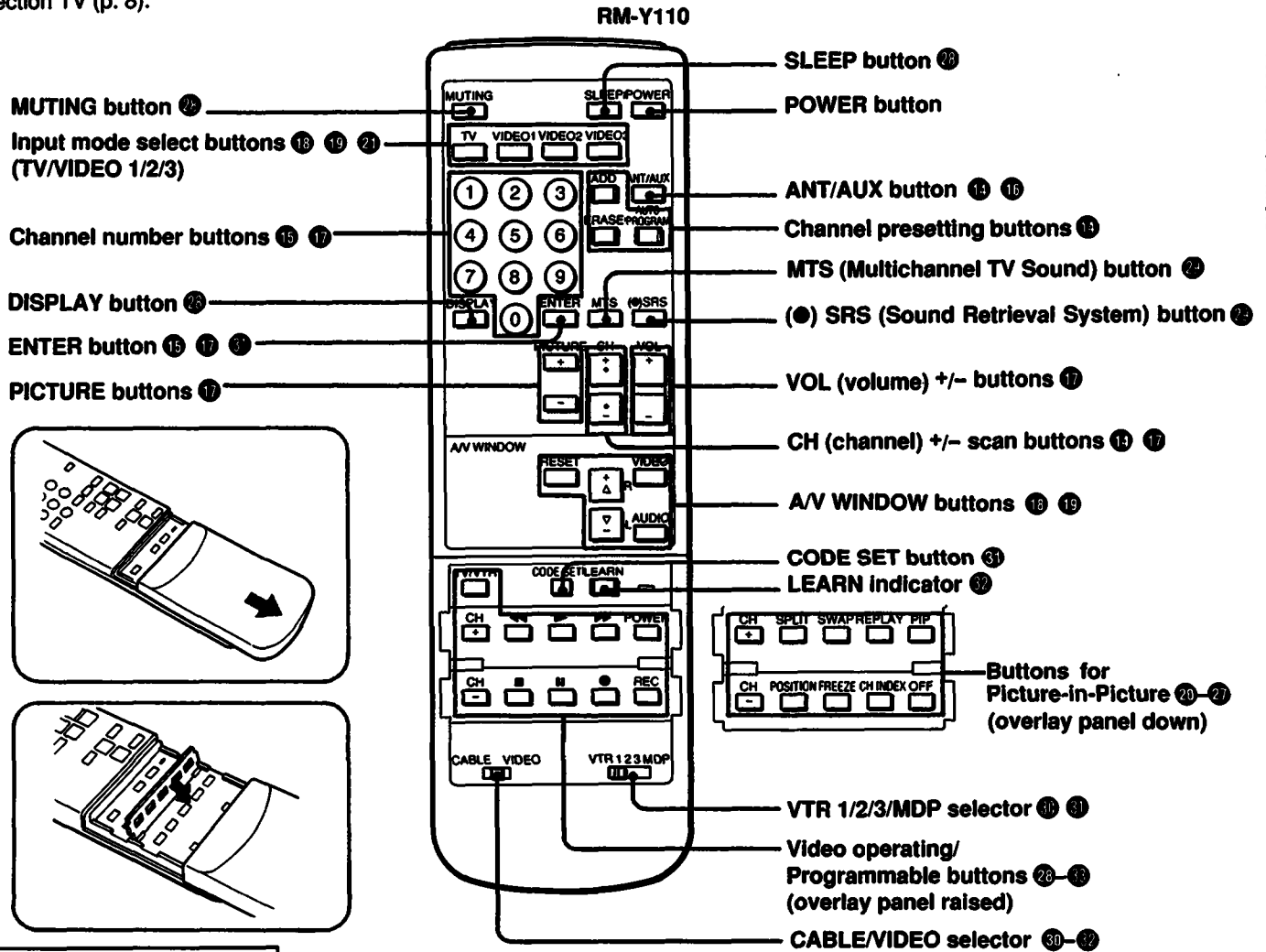

Mini Commander RM-KIT

This Mini Commander has the minimum function buttons needed to operate the projection TV.

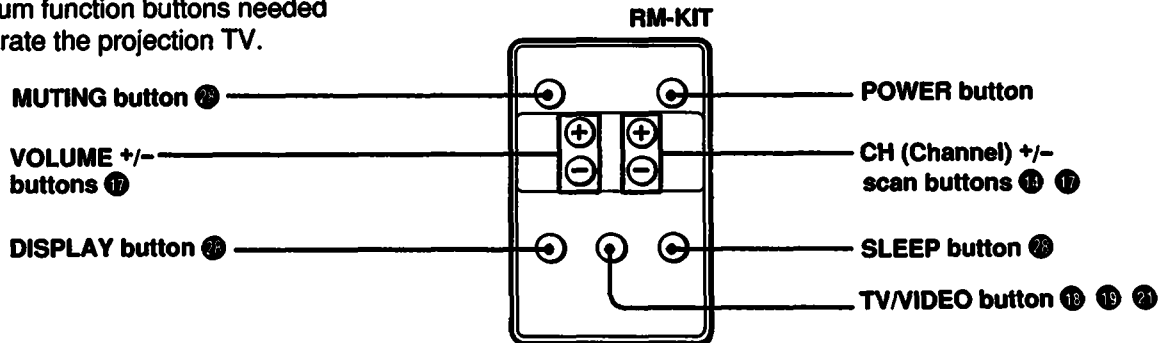

Preparing the Remote Commanders

Battery Installation

Programmable Commander RM-Y110

- 1 Push to open the lid (rear of the commander).

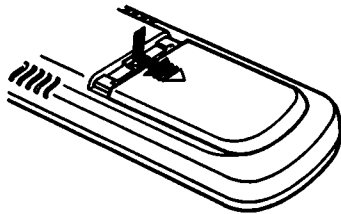

- 2 Install two size AA (R6) batteries in correct polarity.

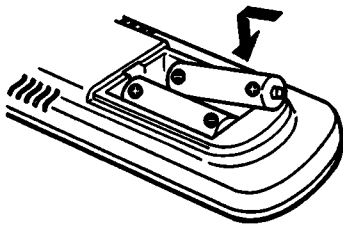

- 3 Replace the lid.

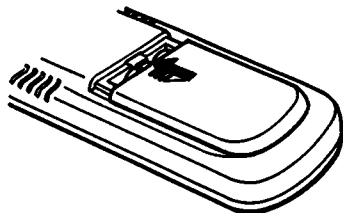

Notes

- With normal operation, batteries will last up to half a year. If the commander does not operate properly, the batteries might be exhausted. Replace all with new ones.
- To avoid damage from possible battery leakage, remove the batteries for extended unused periods.
- Be sure that there are no obstructions between the remote commander and the projection TV.
- Operable range is limited to a 23.5 ft. (7 meter) distance and a 30° angle in each direction.
- If a remote commander that is not recommended is used to operate this projection TV, or if the supplied remote commander is used to operate other equipment, the equipment may not operate properly.

Mini Commander RM-KIT

Before using

The supplied CR2025 lithium battery is already installed in the mini commander. Just remove the transparent insulating slip and it's ready to use.

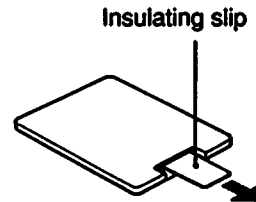

How to replace the battery

- 1 Press a sharp pencil or pen tip into the opening, and slide it towards the edge (1); then pull out the battery case (2).

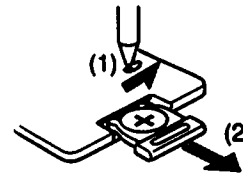

- 2 Insert a new CR2025 lithium battery with the flat surface (positive side) upward.

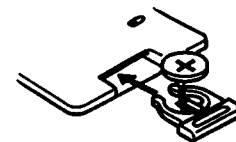

CAUTION

Replace the battery with a Sony CR2025 or Duracell DL-2025 lithium battery only. Use of another battery may present a risk of fire or explosion.

Notes on the lithium battery

- Keep the lithium battery out of the reach of children. Should the battery be swallowed, immediately consult a doctor.
- Be sure to preserve correct polarity when installing the battery.
- Do not hold the battery with metallic tweezers; otherwise a short-circuit may occur.

WARNING

Batteries may explode if mistreated. Do not recharge, disassemble or dispose of in fire.

Connecting TV Antenna/Cable



You can use either an indoor or outdoor antenna with your projection TV. We recommend using an outdoor antenna for better picture quality.

You can receive cable TV by connecting a cable supplied by your local cable company.

To Connect VHF, UHF or VHF/UHF Combination Antenna, or CATV Cable

75-ohm coaxial cable (round)

- 1 Check your antenna cable type and prepare the end of the cable using the F-type connector.

Attach an F-type connector (not supplied).

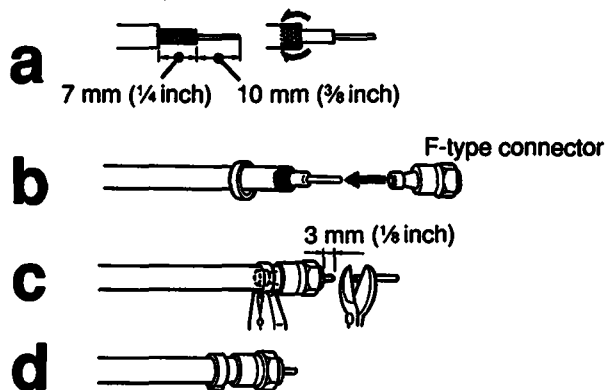

300-ohm twin-lead cable (flat)

- 1 Check your antenna cable type and prepare the end of the cable using the supplied antenna connector.

Attach the supplied antenna connector.

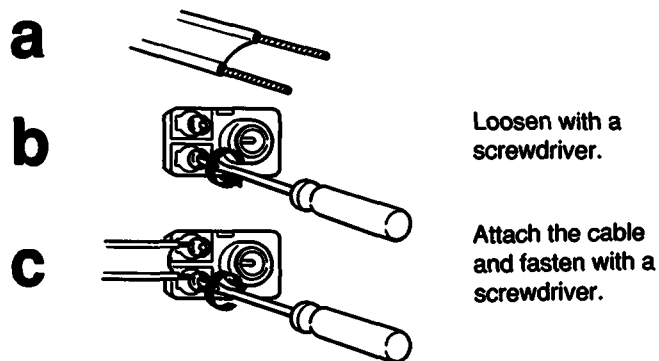

- 2 Plug the connector into the VHF/UHF terminal at the rear of the projection TV.

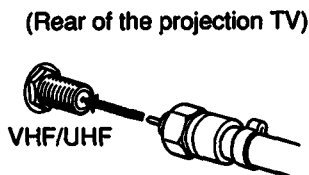

- 2 Plug the connector into the VHF/UHF terminal at the rear of the projection TV.

(Rear of the projection TV)

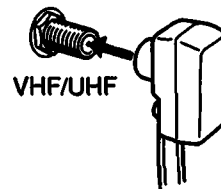

* Most combination antennas are equipped with a signal splitter. Remove the splitter and attach the appropriate connector.

For better picture quality, connect optional antenna cable so that the 300-ohm twin-lead cable can be separated a distance from the projection TV.

(Rear of the projection TV)

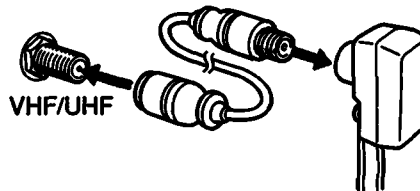

To connect both VHF and UHF antennas

Use the supplied EAC-66 U/V mixer.

- 1** Prepare the VHF antenna end using the appropriate connector.
- 2** Connect the cables to the mixer.
- 3** Attach the mixer to the VHF/UHF terminal.

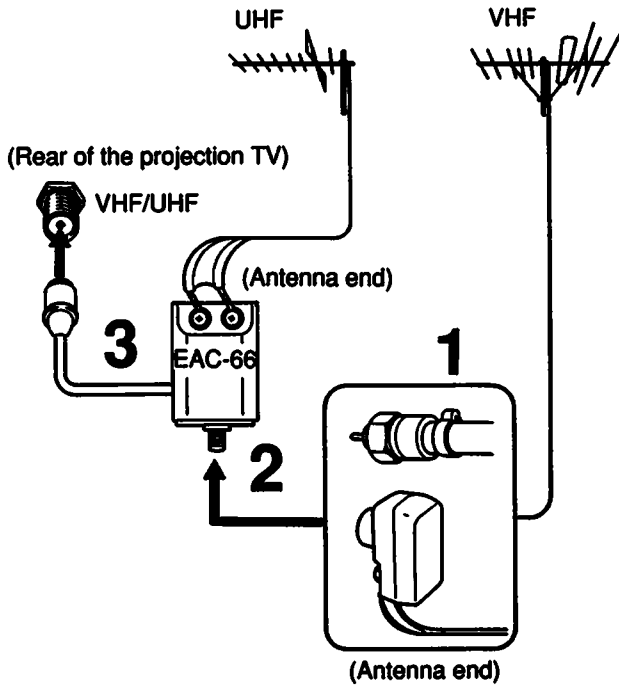

When the U/V mixer is used
Snow and noise (interference) may appear in images of cable TV channels over 37 (W+1).

To connect a cable with a special converter/decoder* for pay cable TV systems

Pay cable TV systems use scrambled or encoded signals and require a special converter (decoder) in addition to the normal cable connection.

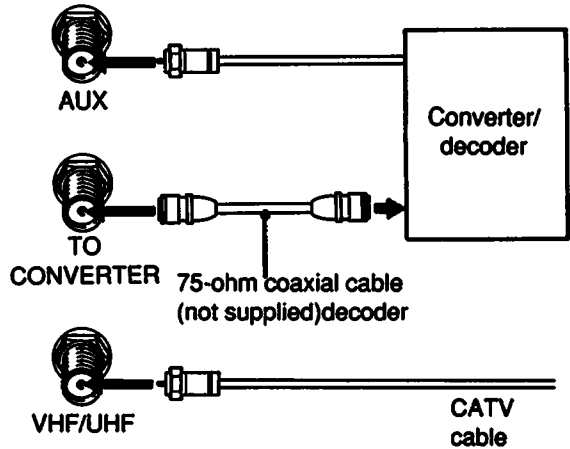

To connect both VHF/UHF antenna and CATV cables

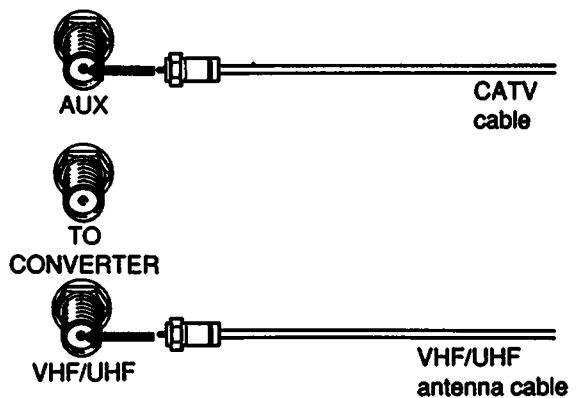

Note
Do not connect anything to the TO CONVERTER terminal in this case.

* The special converter/decoder will be supplied by the cable company.

Adjusting Color Registration

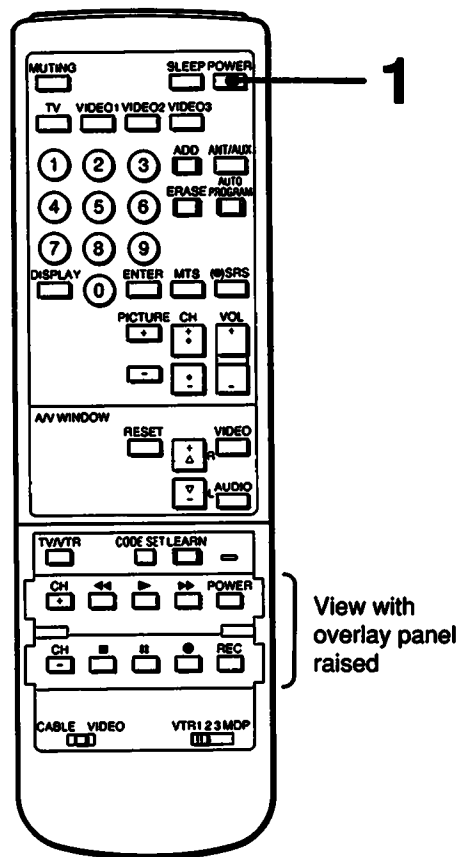
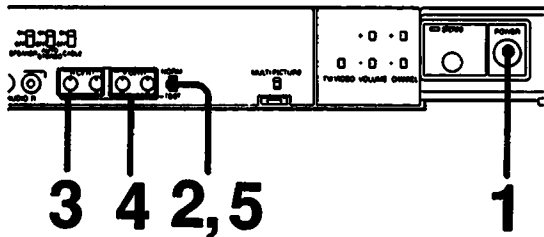

Mixture of Primary Colors

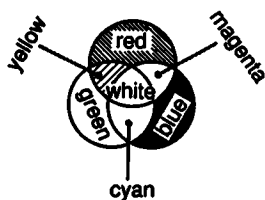

1 Press POWER on the projection TV or commander to turn on the projection TV.

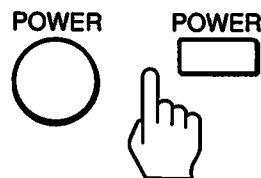

2 Set the NORM/TEST selector on the front panel to TEST.

A test pattern of colored lines will appear.

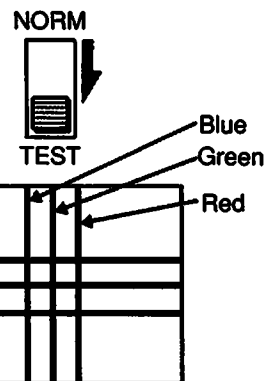

The position of the colored lines will depend on where your projection TV's registration happens to be set.

3 Adjust the H CENT (R) and (B) controls so that the red and blue vertical lines converge with the center green line.

Turn the knobs clockwise to move right, and counterclockwise to move left.

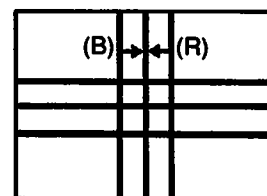
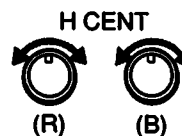

(R) = Red (B) = Blue

4 Adjust the V CENT (R) and (B) controls so that the red and blue horizontal lines converge with the center green line.

Turn the knobs clockwise to move up, and counterclockwise to move down.

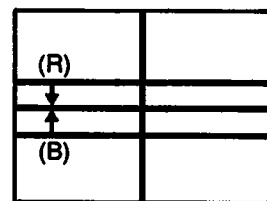
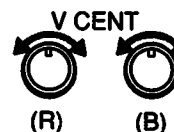

White

Repeat steps 3 and 4 to adjust the lines until the cross appears white.
(Step back from the projection TV to see the effect.)

5 After completing the adjustment, set the NORM/TEST selector to NORM.



Presetting TV Channels

To Preset All Receivable Channels Automatically

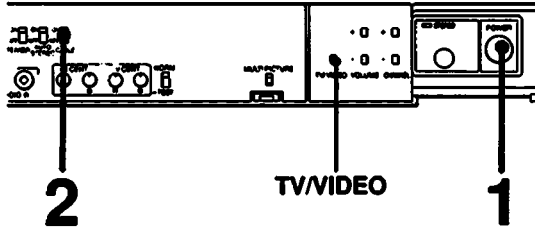

- 1** Press power on the projection TV or commander to turn on the projection TV.

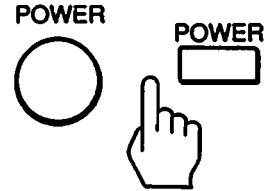

- 2** Set CABLE selector (projection TV) to the appropriate position.

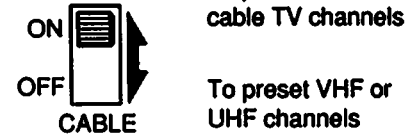

- 3** Press ANT/AUX button (commander) to select the channel mode you want to preset.

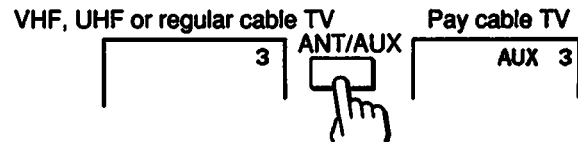

If "VIDEO 1," "VIDEO 2" or "VIDEO 3" is displayed on the screen, press TV on the commander or TV/VIDEO on the projection TV so that a channel number appears.

- 4** Press AUTO PGM button (commander).



"AUTO PROGRAM" is displayed on the screen and receivable channels (other than the channels already preset) will be preset in numerical sequence. The channels previously preset remain in the projection TV's memory.*
When no more channels can be found, the programming stops and the lowest numbered channel is displayed.



- 5** Press CH +/- to check or view preset channels.



Channels that can be received on this projection TV:

VHF: 2-13
UHF: 14-69
Cable: 1-125

To add channels that could not be preset automatically because their signal strength was too weak, or to erase unnecessary channels, follow the steps in "To Preset Only Desired Channels or to Erase Unnecessary Channels" on the next page.

To Preset Only Desired Channels or to Erase Unnecessary Channels

All necessary controls are on the commander.

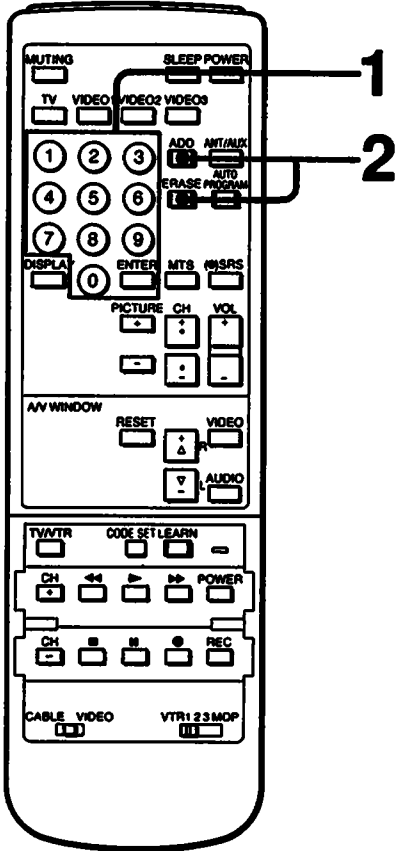

1 Press the channel number button(s) and then ENTER to select the channel you want to add or erase.

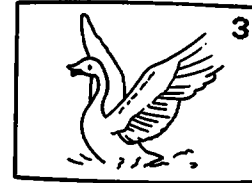
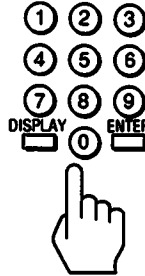

2 To add channels Press ADD.

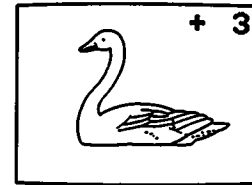

A "+" appears before the channel number for a moment. This channel has now been added to the channel scan memory.

To erase channels Press ERASE.

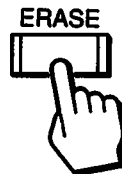

A "-" appears before the channel number for a moment. This channel has now been erased from the channel scan memory.

Repeat steps 1 and 2 to add or erase other channels.

Tip: Erase non-receiving channels so that when you scan channels, only receiving channels will be displayed.

CAUTION

When a VHF or UHF channel is erased
The cable TV channel with the same number is also erased, and vice versa.

Cable TV channel chart*

Cable TV systems use letters or numbers to designate channels. To tune in a channel, refer to the chart below.

Number on this TV	1	5	6	14	15	16	17	18	19	20	21	22	23	24	25	26	27	28	29	30		
Corresponding CATV channel	A-8	A-7	A-6	A	B	C	D	E	F	G	H	I	J	K	L	M	N	O	P	Q		
	31	32	33	34	35	36	37	38	39.....	93	94	95	96	97	98	99	100	101	102.....	123	124	125
	R	S	T	U	V	W	W+1	W+2	W+3.....	W+57	W+58	A-5	A-4	A-3	A-2	A-1	W+59	W+60	W+61.....	W+82	W+83	W+84

Check with your local cable TV company for more complete information on the available channels.

*This designation of cable TV channels conforms to the EIA/NCTA recommendation.

Watching TV Programs

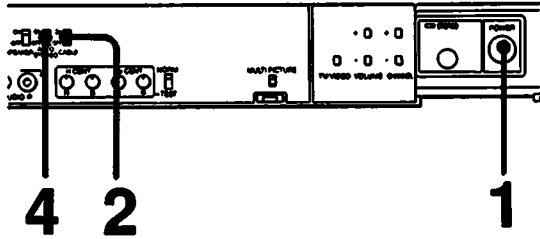

1 Press POWER on the projection TV or commander to turn on the projection TV.

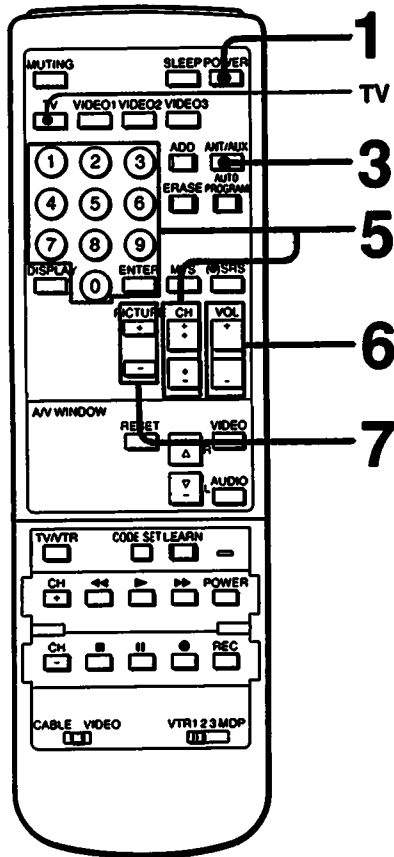
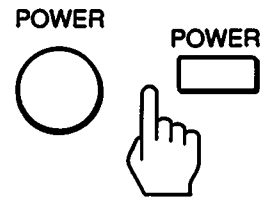

2 Set CABLE selector (projection TV) to the appropriate position.

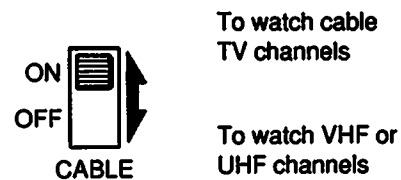

3 Press ANT/AUX (commander) to select the channel mode you want to watch.

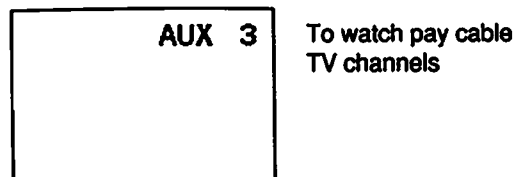
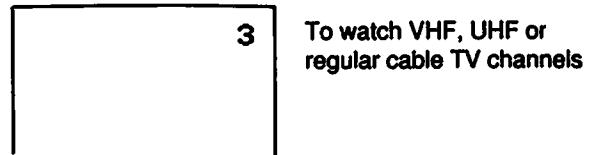

If "VIDEO 1," "VIDEO 2" or "VIDEO 3" is displayed on the screen, press TV on the commander or TV/VIDEO on the projection TV so that a channel number appears.

To turn off the projection TV
Press POWER again.

4 Set AUTO STEREO selector (projection TV) to ON.



5 Select a channel in one of the following ways (controls on commander):

To scan the preset channels in numerical sequence
Press CH +/-.

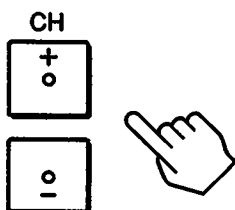

To select a channel directly

Press the channel number button(s) and then ENTER.
For example, to select channel 10, press 1, 0 and ENTER.

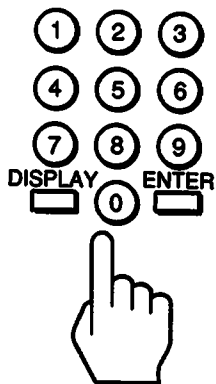

6 Press VOL + or - (commander) to adjust the volume.

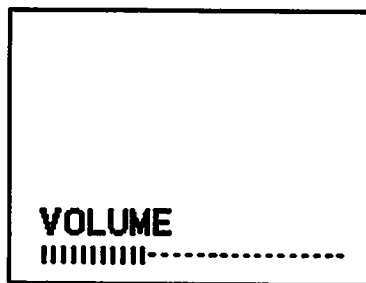
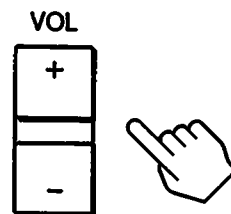

7 Press PICTURE + or - (commander) to adjust the picture.

To increase picture contrast with vivid color.

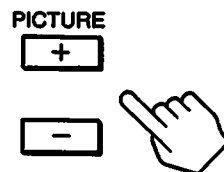

To decrease picture contrast with soft color.

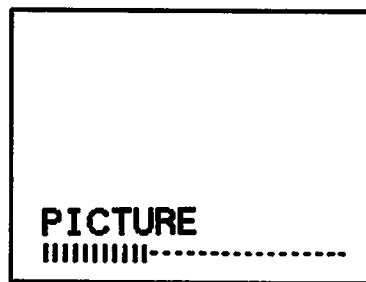

Adjusting Picture and Sound Quality

You can set different picture and sound quality levels for each input mode by changing the input mode (TV/VIDEO 1/2/3) before setting. These settings will be retained even when you turn the projection TV off.

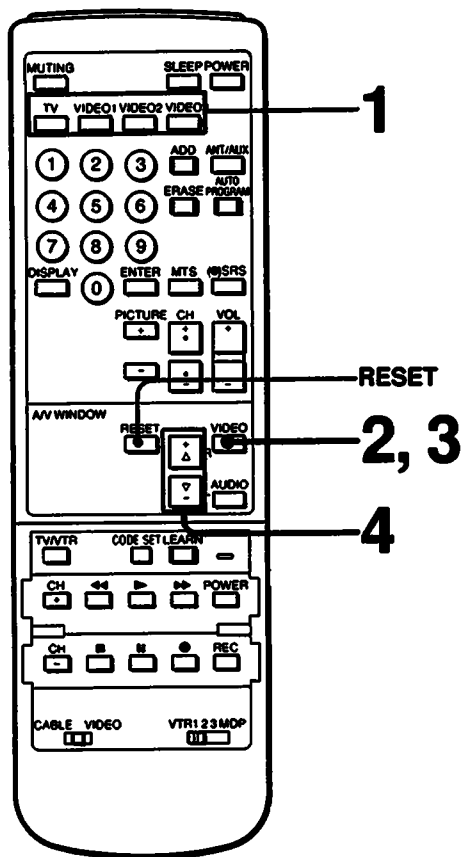

Adjusting the Picture

1 Select the input mode you want to adjust with the TV/VIDEO 1/2/3 buttons.

2 Press VIDEO.

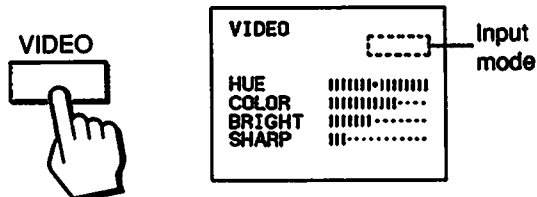

3 Press VIDEO repeatedly until the quality you want to adjust blinks.

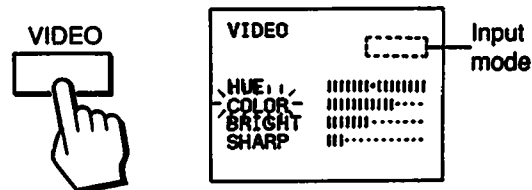

4 Press (R) or (L) to make the adjustment.

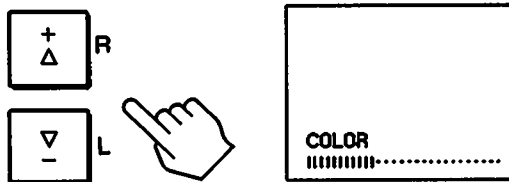

Picture quality	Press -(L) button	Press +(R) button
HUE	Skin tones become purplish	Skin tones become greenish.
COLOR	For less color intensity	For more color intensity
BRIGHT	For less brightness	For more brightness
SHARP	For less sharpness	For more sharpness

The display will disappear automatically after a few seconds.

To restore the factory (mid-level) settings

Press RESET.

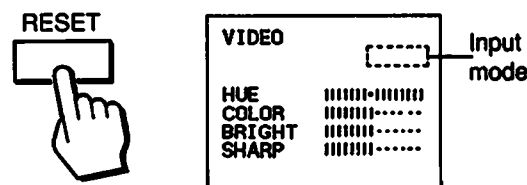

The display will disappear after a few seconds.

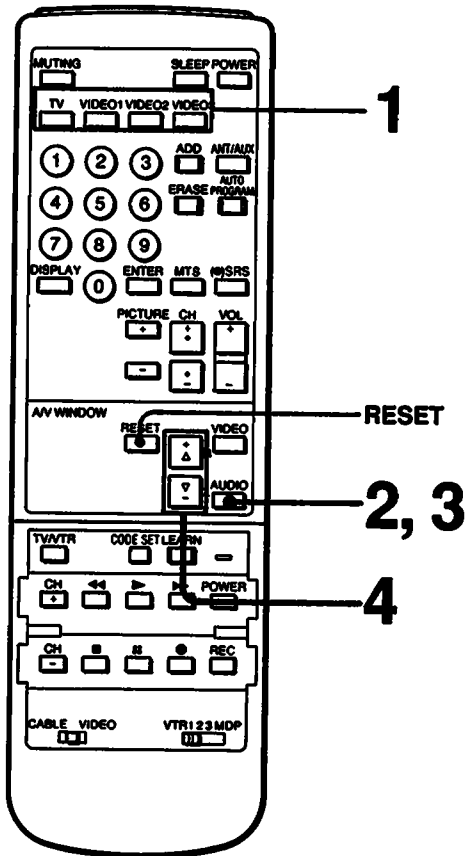

Adjusting the Sound

1 Select the input mode you want to adjust with the TV/VIDEO 1/2/3 buttons.

2 Press AUDIO.

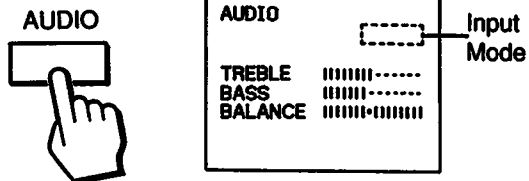

3 Press AUDIO repeatedly until the quality you want to adjust blinks.



4 Press (R) or (L) to make the adjustment.

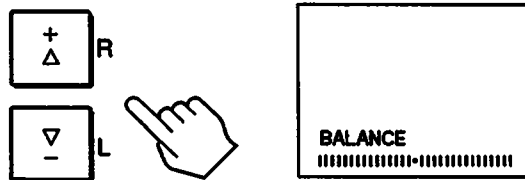

Sound quality	Press -(L) button	Press +(R) button
TREBLE	To decrease treble response	To increase treble response
BASS	To decrease bass response	To increase bass response
BALANCE	To emphasize the left speaker's volume	To emphasize the right speaker's volume

The display will disappear automatically after a few seconds.

To restore the factory (mid-level) settings

Press RESET.

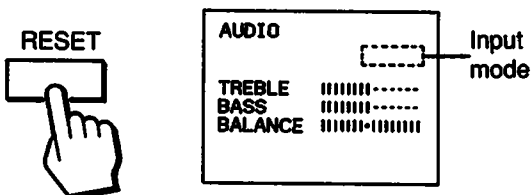

The display will disappear after a few seconds.

Using Picture-in-Picture

Besides the main picture, you can watch another TV channel, video or pay cable TV source simultaneously, as a window picture.

For example, use Picture-in-Picture when there are two TV channels you want to watch at the same time, or when you want to monitor VCR dubbing while watching TV.

Remote commander
RM-Y110

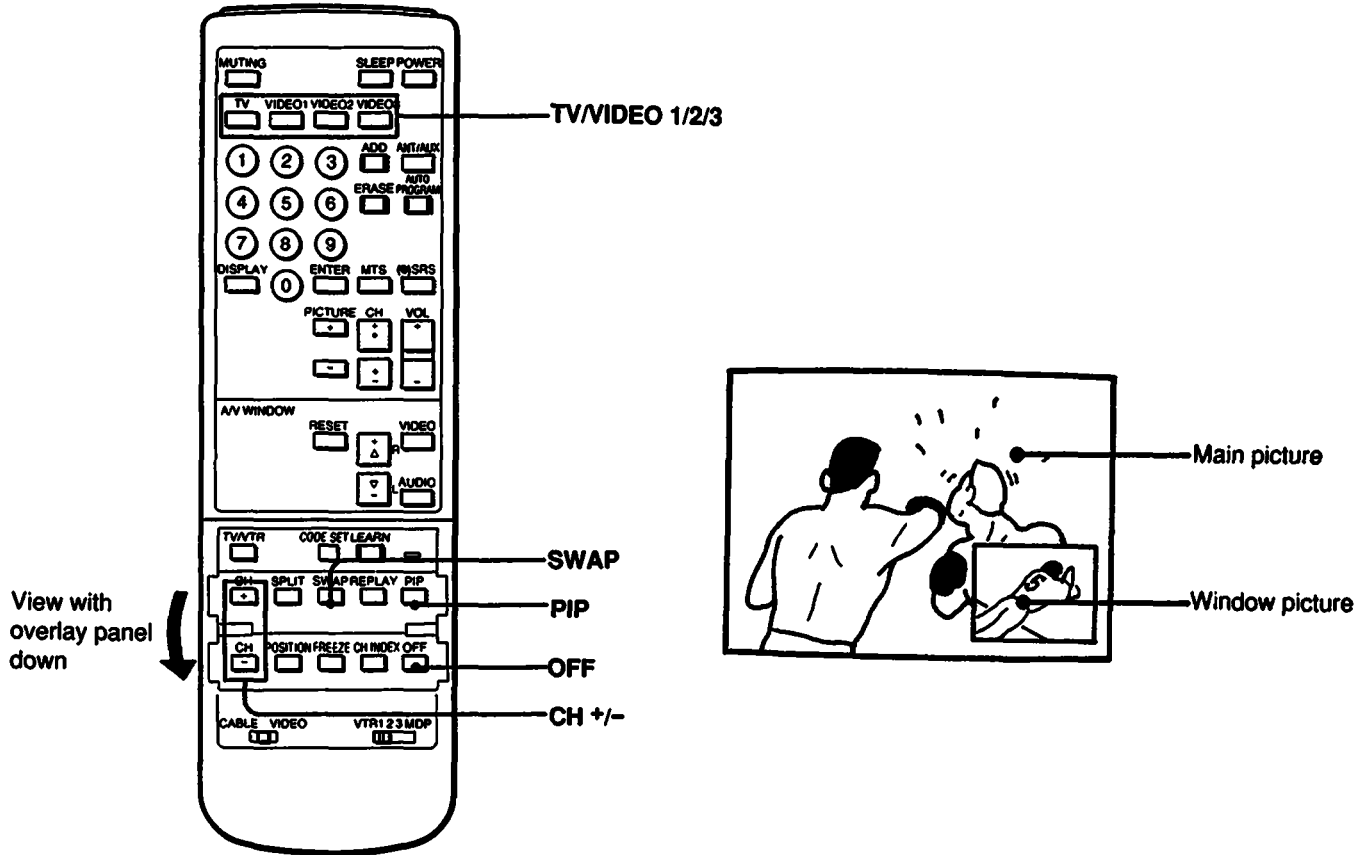



To display a window picture – PIP

Press PIP.

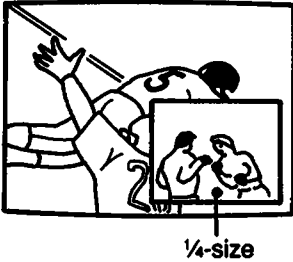
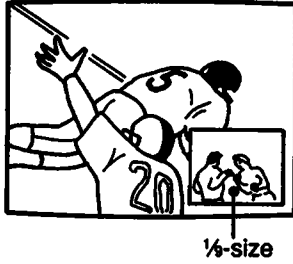

A window picture will appear (in the same mode as the last time you used PIP).

The picture will change to 1/4 and 1/8 size alternately, each time you press PIP.

Picture-in-Picture also functions when the main picture is in the VIDEO mode.

To make the window picture disappear
Press OFF.

To scan channels in the window picture
Press CH +/- in the commander's Picture-in-Picture control section.

To change the input mode
Press the input select button (TV/VIDEO 1/2/3).

Note
You cannot hear sound from the window picture channel.

To swap the main and window pictures – SWAP

1 Press PIP to display a window picture.

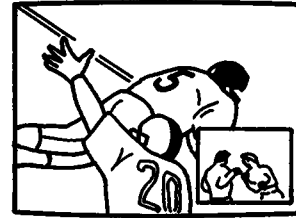

2 Press SWAP.

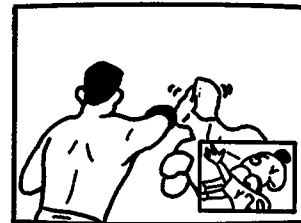

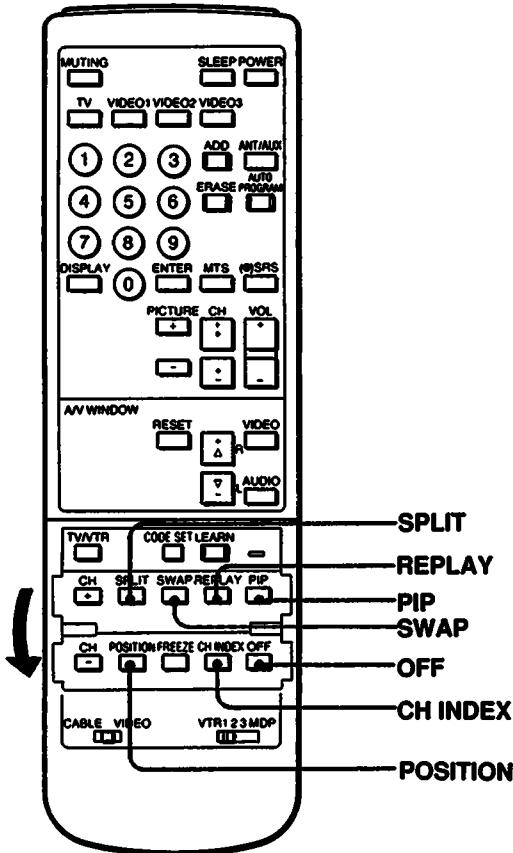

To change the position of the window picture - POSITION

1 Press PIP to display a window picture.

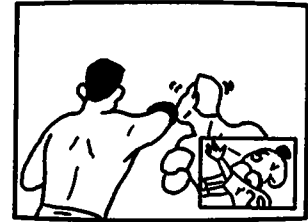

2 Press POSITION. Each time you press POSITION, the window picture will move counterclockwise on the screen as illustrated.

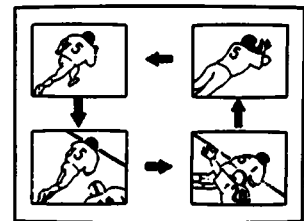

To replay the main picture as a window picture - REPLAY

Press REPLAY. The immediately preceding three seconds of images will be replayed as a window picture, and will keep replaying until you press OFF.

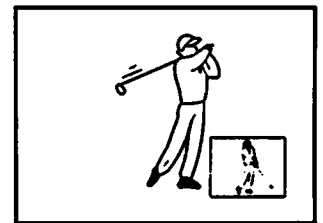

To make the replay picture disappear
Press OFF.

Note
The replay picture is always displayed in 1/9 size.



To split the screen into half main and half window picture - SPLIT

Press SPLIT.

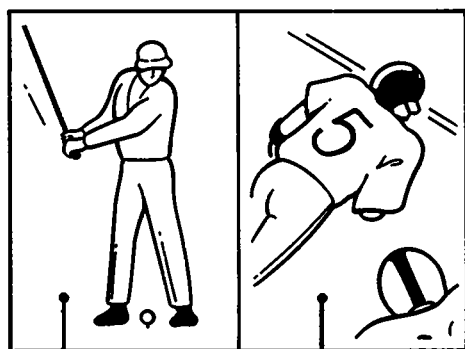

Window Picture

Main Picture

To make the window picture disappear
Press OFF.

Notes

- Only the sound of the main picture (right screen) is heard.
- When using the split-screen feature, images may appear vertically elongated.
- To swap the main and window pictures in the split screen, press SWAP.

To display seven different window pictures simultaneously - CH INDEX

Press CH INDEX.

CH INDEX

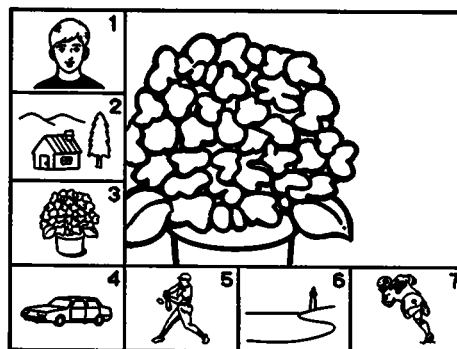

Programs of seven different TV channels appear in numerical sequence as window pictures.

CH INDEX

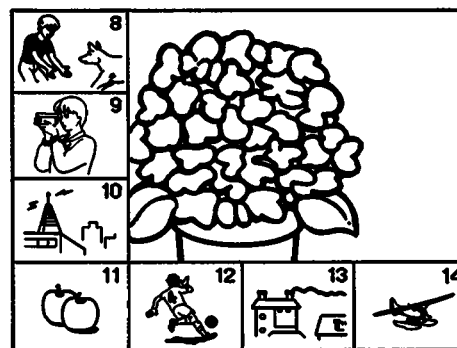

Each time you press CH INDEX, the next seven channels will appear.

To cancel CH INDEX
Press OFF.

Notes

- When using the CH INDEX function, part of the main picture is hidden by the window pictures.
- Full movement is not reproduced in CH INDEX images.

Using Picture-In-Picture

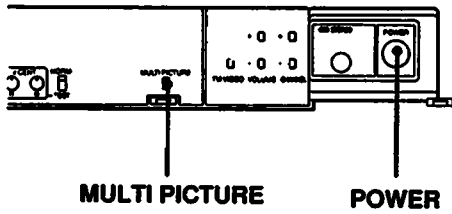

**To demonstrate all the Picture-in-Picture features one by one
- MULTI PICTURE**

Press MULTI PICTURE on the projection TV.
The features will be demonstrated in the order shown below, each time you press MULTI PICTURE.

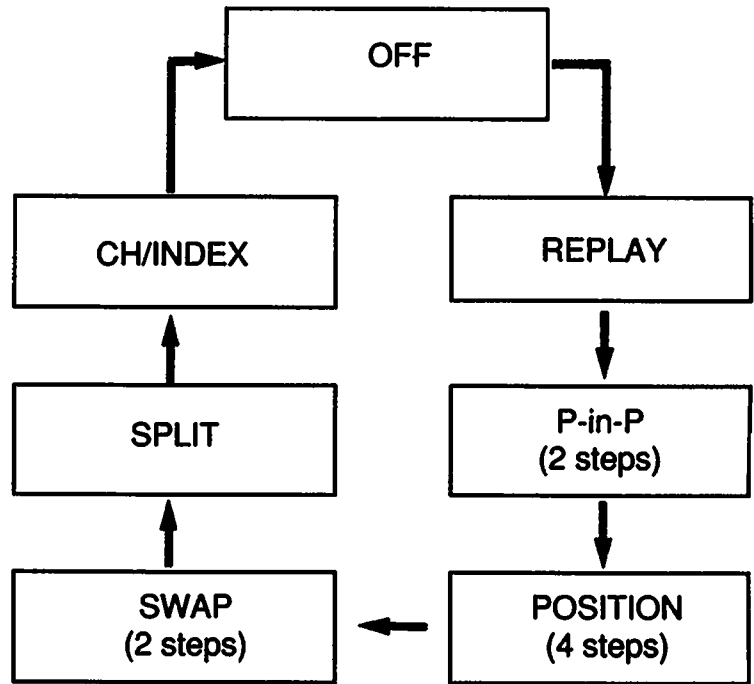
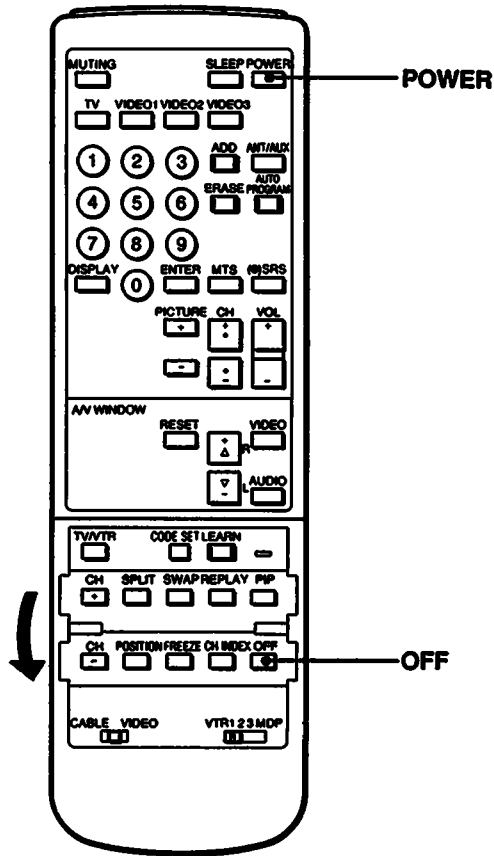

**To cancel the demonstration
Press OFF.**



To freeze a TV picture - FREEZE

Press FREEZE.

The TV picture will freeze.

Use this feature when you want to write down a recipe from a cooking program, a displayed toll free number, etc.

FREEZE

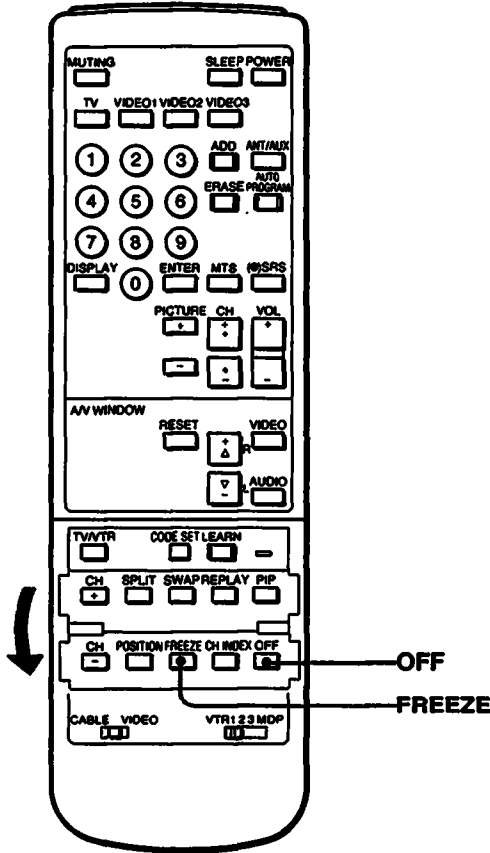
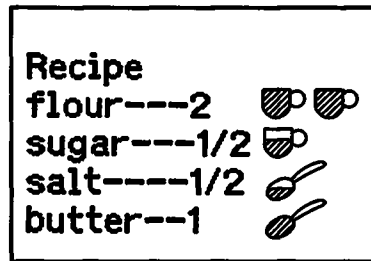

Note

The broadcast will be progressing normally while the still picture is on the screen.

To restore the normal picture

Press OFF.

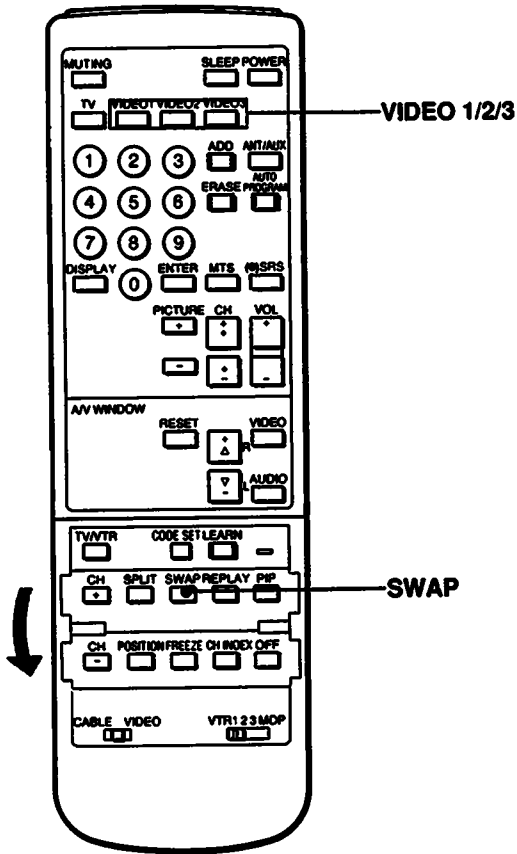

To display the VIDEO input image as a window picture

To watch VIDEO images (VCR playback or TV through a VCR tuner) using Picture-in-Picture, first select the channel mode by following step 3 on page 16, "Watching TV Programs." Then follow the steps below.

1 Press VIDEO 1, 2 or 3 to select the appropriate input mode.

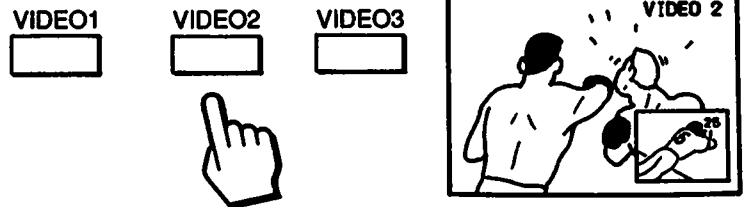

The video image from the input mode you select will appear as the main picture.

2 Press SWAP so that the video input picture becomes a window picture.



3 Press SWAP again to change the video input picture back to the main picture.



You can only change VIDEO input modes of the main picture.

Note

To operate your VCR with the supplied remote commander, see pp. 30-33 — "Using the Programmable Remote Commander."

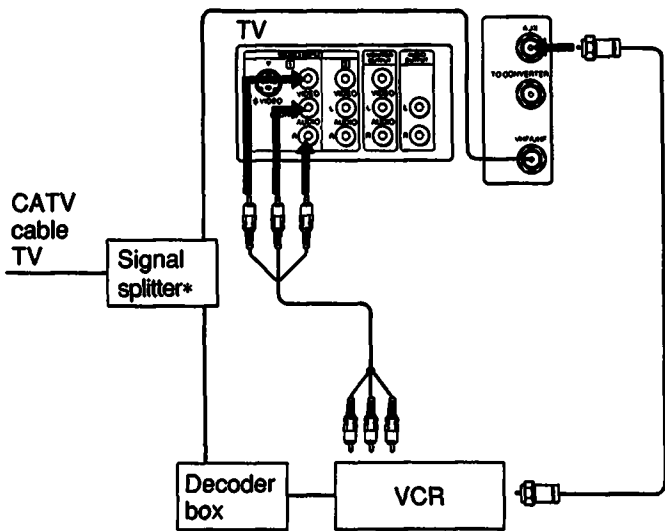

* The signal splitter is not supplied with your projection TV. Please consult your local cable company regarding the signal splitter.

To display pay cable TV as a window picture

To watch pay cable TV using Picture-in-Picture, first select the proper modes by following steps 2 and 3 on page 16, "Watching TV Programs."

Then follow the steps below.

Note

The channels being received through the AUX terminal cannot be displayed as a window picture, except as a REPLAY picture (p. 22) or SPLIT picture (p. 23).

1~3 Follow the same steps as 1~3 in "To display the VIDEO input image as a window picture" (page 25).

4 Put your VCR on an inactive channel (CH 3 or 4).

5 Change pay cable TV channels with the decoder box.

Note

To control your VCR or remote controlled decoder box with the supplied remote commander, see p. 32 (Learning Function).

Enjoying Other Useful Features

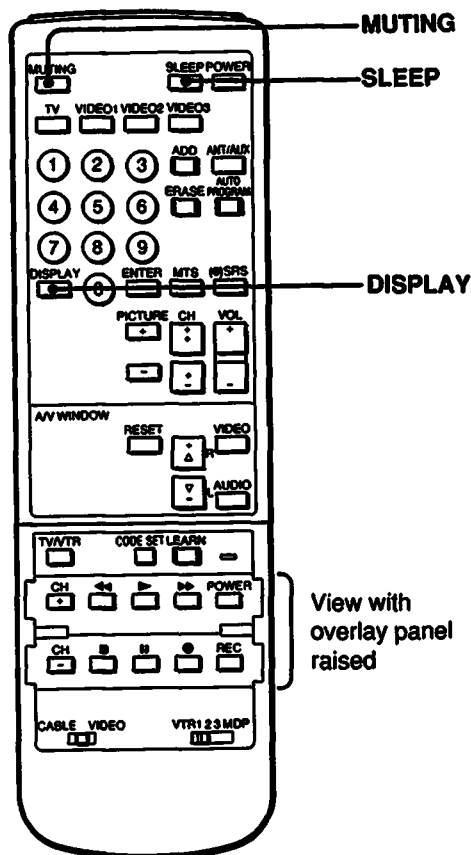

View with
overlay panel
raised

Muting the sound - MUTING

Press **MUTING**.

The display "MUTING" will appear on the screen.

MUTING



To restore the sound

Press **MUTING** again, or press **VOL +**.

Keeping the channel displayed - DISPLAY

Press **DISPLAY**.

All the current displays will appear for a few seconds, then disappear. The channel display will remain on the screen.

DISPLAY



To cancel the display

Press **DISPLAY** again.

The channel display will disappear.

Using the sleep timer - SLEEP

Turns the TV off automatically about 1 hour after setting.

Press **SLEEP**.

A green "SLEEP ON" display will appear for a few seconds.

SLEEP

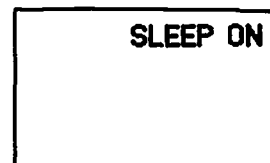

A red "SLEEP" display will appear 1 minute before the TV shuts off.

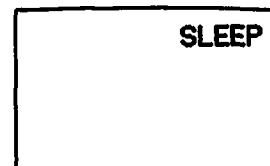

To cancel

Press **SLEEP** again.

A green "SLEEP OFF" display will appear for a few seconds.

SLEEP

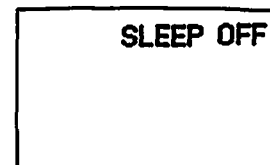

The sleep timer setting is also cancelled when you turn the TV off.

For more natural sound reproduction - (●) SRS

To reproduce the dynamics of a live performance - Sound Retrieval System.

Press SRS.

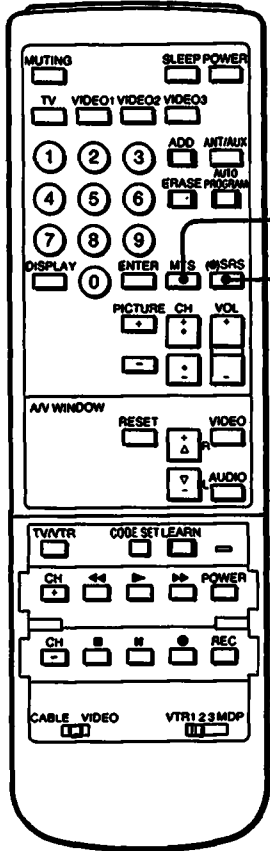

Each time you press SRS, the SRS (STEREO), SRS (MONO) and SRS OFF modes are selected in sequence. The display (in green) for each mode will appear on the screen for a few seconds.



In SRS (STEREO) mode, stereo sound is enhanced.

In SRS (MONO) mode, the natural sound of a monaural source is enhanced.

To cancel SRS
Select SRS OFF.

Receiving a Multichannel TV Sound program - MTS

Each time you press MTS, the MAIN, SAP (SECOND AUDIO PROGRAM) and BOTH modes are selected in sequence. The display (in green) for each mode will appear below the channel number for a few seconds.



Note
During SAP mode, the sound of non-SAP programs will be muted.

To listen to stereo sound, press MTS to select the MAIN mode. The MAIN display will appear for a few seconds.

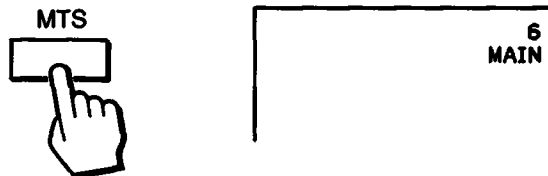

The STEREO indicator lamp on the projector will light up whenever a stereo broadcast is received.

Using the Programmable Remote Commander

You can operate other video equipment that have an infrared remote detector with the supplied RM-Y110 remote commander.

Operating Sony Video Equipment

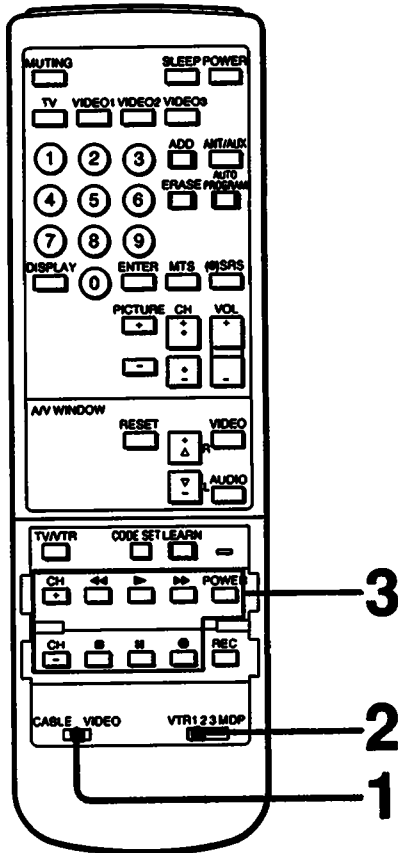

With the supplied remote commander, you can operate Sony video cassette recorders (Beta, 8mm, VHS) and multi disc players by following the steps below.

- 1 Set the CABLE/VIDEO selector to VIDEO.

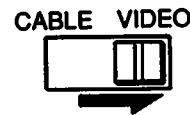

- 2 Set the VTR 1/2/3/MDP selector according to the video equipment you want to operate.

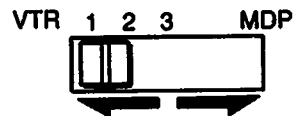

If you want to operate a:	set to:
Beta, ED Beta VCR	VTR 1
8mm VCR	VTR 2
VHS VCR	VTR 3
Video disc player	MDP

- 3 Use the video operating buttons to operate video equipment.

Operating a Video Cassette Recorder

- | | |
|--|---|
| To record | Press ●. |
| To play | Press ►. |
| To stop | Press ■. |
| To fast forward | Press ►►. |
| To rewind the tape | Press ◄◄. |
| To freeze a picture | Press ■■. |
| | <i>To resume normal playback, press again.</i> |
| To search the picture forward and backward | Keep pressing ►► or ◄◄ during playback. |
| | <i>To resume normal playback, release the button.</i> |

Operating a Video Disc Player

- | | |
|--|---|
| To play | Press ►. |
| To stop | Press ■. |
| To freeze a picture | Press ■■. |
| | <i>To resume normal playback, press again.</i> |
| | *This function is effective only for CAV (standard-play disc). With CLV (extended-play disc), the projection TV will go into the standby mode if ■■ is pressed. |
| To search the picture forward and backward | Keep pressing ►► or ◄◄ during playback. |
| | <i>To resume normal playback, release the button.</i> |

Caution

When you replace the batteries, do it within approximately 30 minutes. Otherwise, Sony settings and all of the settings you made under the Pre-Programmed function may be erased.

Notes

- If you use only Sony video equipment with your projection TV, you can operate that equipment following the steps on this page only. However, if you use other makers' video equipment as well as Sony's, please follow the steps on p. 31 instead (Pre-Programmed function).
- If the video equipment does not have a certain function, the corresponding button on this remote commander will not operate.



Operating Non-Sony or Sony Video Equipment (Pre-Programmed Function)

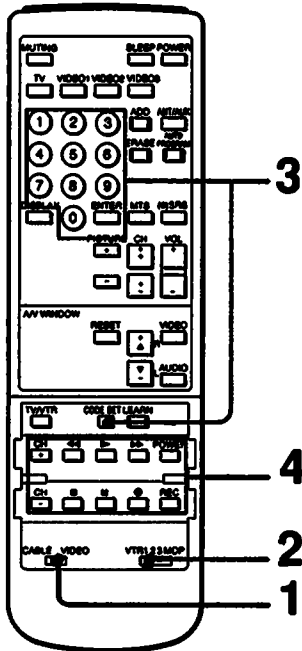

With the supplied remote commander, you can operate non-Sony or Sony video equipment as shown below.

Example: To operate an RCA video cassette recorder when you set the VTR 1/2/3/MDP selector to VTR 2.

- 1 Set the CABLE/VIDEO selector to VIDEO.

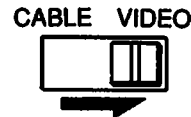

- 2 Set the VTR 1/2/3/MDP selector to VTR 2.

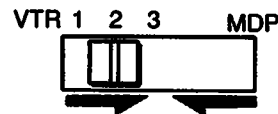

By employing the VTR 1/2/3 settings, you can use your remote commander to operate up to 4 pieces of equipment.

Note: If you also use Sony video equipment, set other makers' equipment to a position not being used for your Sony video equipment.

Manufacturers and Code Numbers (VCR)

MANUFACTURER	CODE
SONY	01, 02, 03, 04
EMERSON	22, 33, 30
SHARP	13, 14
RCA	07, 08
HITACHI	07
FUNAI	29
MAGNAVOX	05, 06, 09
mitsubishi	18, 19, 26, 27
PANASONIC	05
GENERAL ELECTRIC	05
JVC	16
GOLDSTAR	25
TOSHIBA	20, 21
SYLVANIA	05, 06, 09
ZENITH	17
SANYO	11, 15
QUASAR	05
NEC	16, 23, 31
PHILIPS	05, 06, 09
TOTE VISION	25
SAMSUNG	24, 32
SYMPHONIC	29
FISHER	10, 11, 12
TEKNIKA	28, 29
CANON	05
PHILCO	05, 06
SCOTT	21
MULTITECH	29
SHINTOM	34

- 3 While pressing CODE SET, press the number buttons for your manufacturer's code number (see charts). For RCA, press 0, 7 and ENTER.

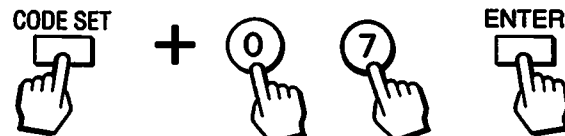

Now you can operate the video equipment with the supplied remote commander.

Notes

- If more than one code number is listed, try entering them one by one, until you come to the correct code for your equipment.
- If you enter a new code number, the code number previously entered at that setting will be erased.

- 4 Use the video operating buttons to operate video equipment (see the chart on p. 30).

Manufacturers and Code Numbers (Video Disc Player)

MANUFACTURER	CODE	MANUFACTURER	CODE
SONY	04	YAMAHA	53
PIONEER	51	MARANZ	54
RCA	51	PANASONIC	55
MITSUBISHI	51	SHARP	56
PHILIPS	52	SANYO	57
MAGNAVOX	52	KENWOOD	58

Operating Audio and Video Equipment (Learning Function)

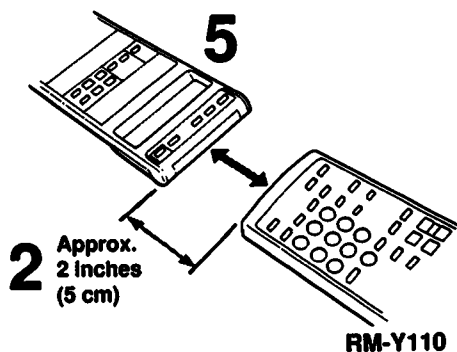
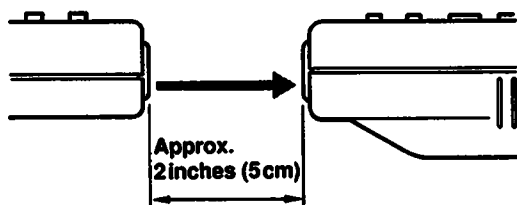
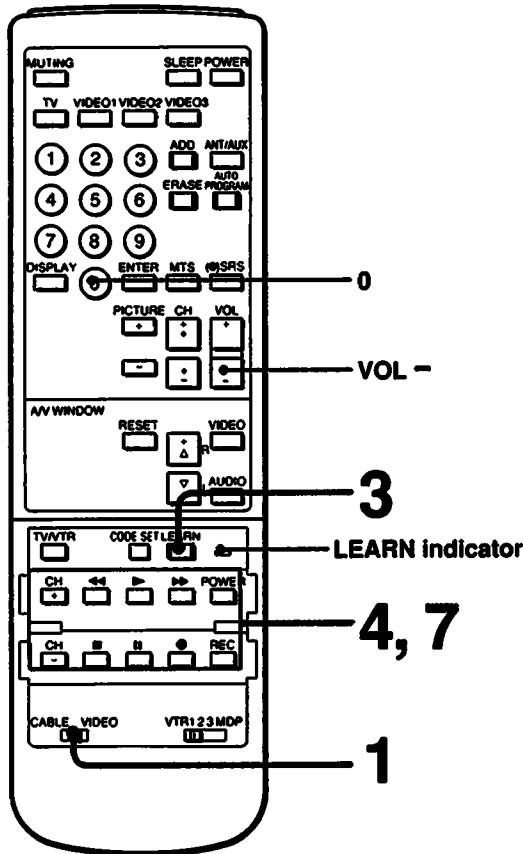

With this feature, you can “teach” any of the programmable buttons to operate one function each of another remote commander. Use the Learning function to program the supplied remote commander to operate non-Sony and Sony audio equipment, your remote controlled cable decoder box, and video equipment of manufacturers not listed in the chart on p. 31.

- 1 Set the CABLE/VIDEO selector to CABLE.

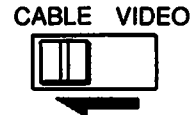

- 2 Position the supplied remote commander and the other remote commander head to head, approximately 2 inches (5cm) apart. (see illus.) For accurate learning, do not move the two remote commanders during the learning process.

- 3 Press LEARN.
The LEARN indicator lights up (green).



- 4 Briefly press the button on the supplied remote commander, which you want to use for a particular function (ex: POWER).
The LEARN indicator turns from green to red, and a short beep will sound.
If you press a button which is not programmable, the LEARN indicator will change from red to green, and a long beep will sound.

- 5 Press and hold down the corresponding function button on the other remote commander until the LEARN indicator goes out. (A long beep is sounded.)
The LEARN indicator lights up (green). If this does not happen, the Learning process has not been completed. Repeat steps 4 and 5.

- 6 To program other buttons, repeat steps 4 and 5.
When a new function is assigned to a button, the previously learned function is cleared automatically.

- 7 Use the programmable buttons to operate video equipment (see chart on p. 30).

To clear the learned functions

Follow steps 1–3 on p.32.

Then press and hold down the "0" and "VOL–" buttons on the supplied remote commander simultaneously. Keep them held down until you hear 6 short beeps.

Press LEARN.

All the learned functions are now erased.

Notes

- After using Learning, test the function to make sure it has been learned. The signals of some maker's commanders cannot be stored in this commander.
- You cannot use the learning function for equipment other than video and audio.
- When operating equipment with learned functions, the selectors should be set in the same pattern as they were when the functions were learned.
- The learning function will not work in the following cases:

Problem	Solution
A fluorescent lamp or equipment which emits infrared energy is nearby.	Move the remote commanders away from the infrared source.
The batteries are exhausted.	Replace the batteries with new ones.
There is an obstacle between the remote commanders, or the remote commanders are not positioned head to head and exactly aligned (see illus. on p. 32).	Remove the obstacle and position the remote commanders properly.

Using Optional Equipment

This projection TV is equipped with various input/output jacks and terminals for connecting optional equipment.

For further details, refer to the page number next to each item.

Front

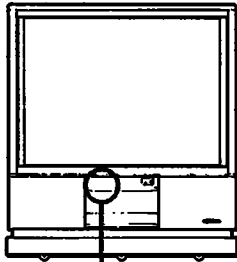

Rear

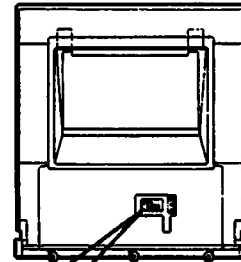

VIDEO 2 IN (input) jacks (phono type) 37
Connect to a VCR or microcomputer.

VIDEO 1 S VIDEO jack (4-pin mini DIN type) 38
Connect to a VCR equipped with the S video output jack. When this jack is connected, even if the "VIDEO" jack (phono type) of the VIDEO 1 INPUT is connected, the picture to be monitored is switched automatically to the signal from this jack.

AUDIO OUTPUT jacks (phono type) 38
Connect to the audio input jacks of audio equipment. The audio signal of either the TV or VCR, as selected by the TV/VIDEO button, is supplied. The volume of the equipment connected to these jacks can be adjusted by the VOLUME +/- button on the projection TV, or the VOL +/- button on the remote commander.

VIDEO 1 INPUT jacks (phono type) 39
Connect to a VCR*, video disc player, etc.

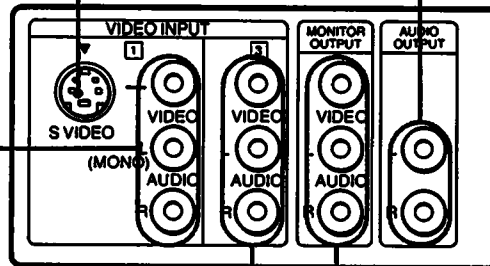

VIDEO 3 INPUT jacks (phono type) 40
Connect to a VCR, video disc player or audio equipment, etc.

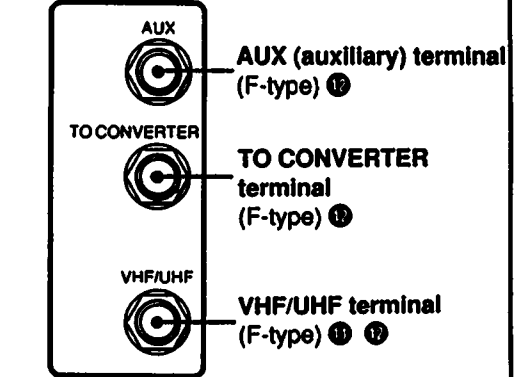

MONITOR OUTPUT jacks (phono type) 41
Connect to a VCR or color monitor. Either the TV or VCR signal selected by the TV/VIDEO button or the input mode select buttons is supplied.

* You will achieve better picture and sound quality by connecting through VIDEO INPUT than by connecting the VCR only to the antenna terminals.

Notes on connection

- Before connecting, make sure you turn off the power on all equipment.

- The plugs should be fully inserted into the jacks. A loose connection may cause hum and noise.
- Match colors when connecting the plugs to the jacks.



Connecting Video Equipment

Connecting VCRs/Video Disc Players Not Equipped with the S Video Output Jack

➤ : Signal flow

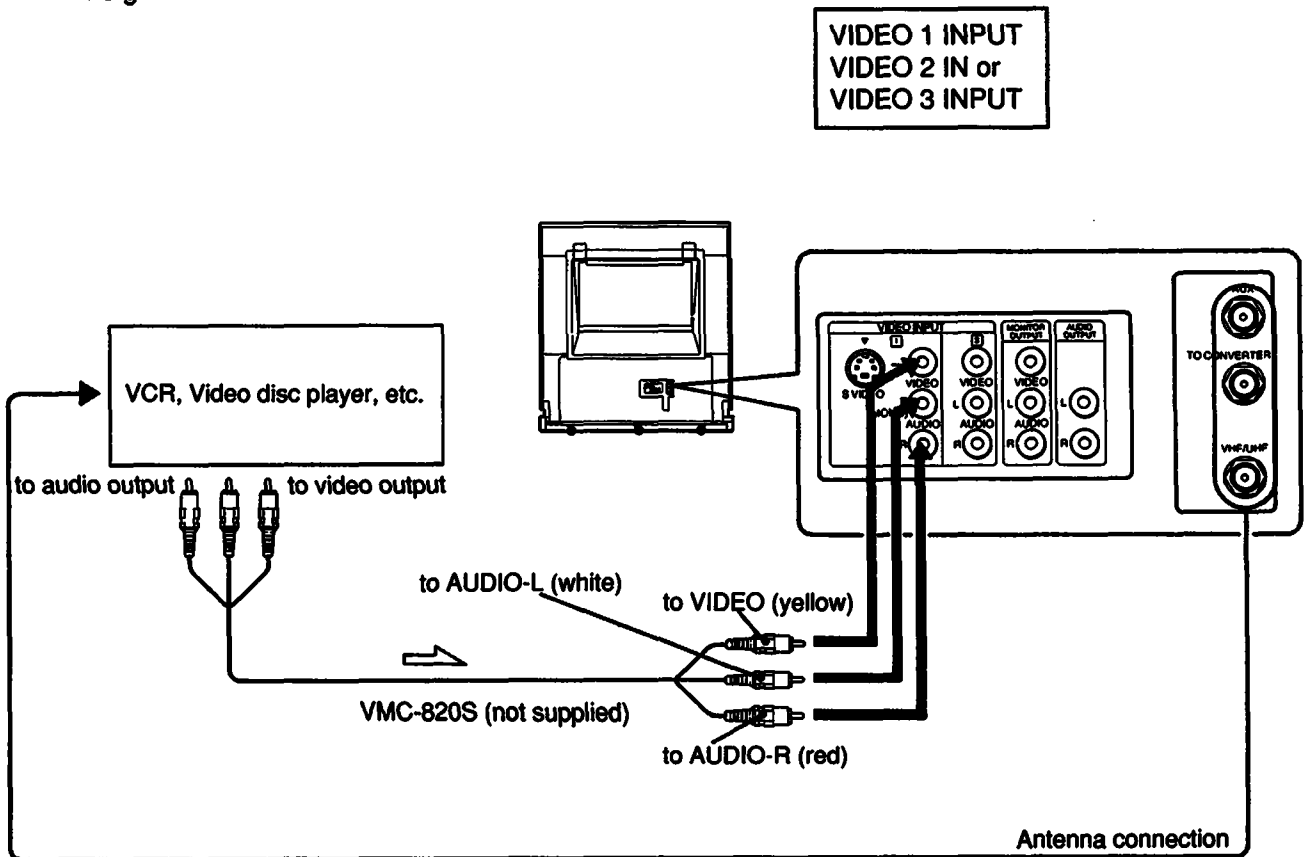

After connecting, you will be able to

- Play video tapes
- Record TV programs
- Record one TV program while watching another

Caution

Television programs, films, video tapes and other materials may be copyrighted. Unauthorized recording of such material may be contrary to the provisions of the copyright laws.

Connecting Video Equipment

Connecting VCRs Equipped with the S Video Output Jack

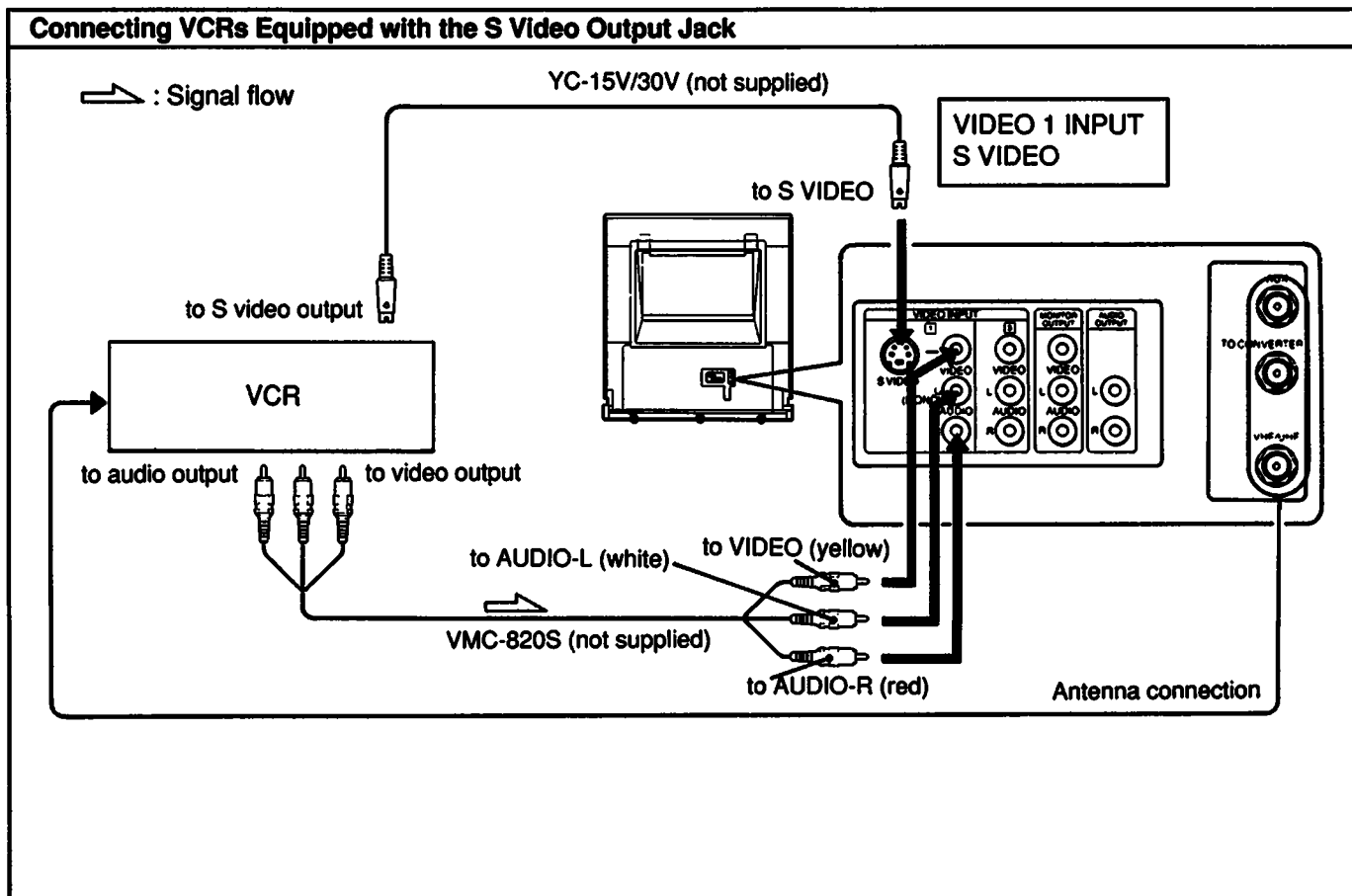

After connecting, you will be able to

- Play video tapes
- Record TV programs
- Record one TV program while watching another

Note

In order to display a video image in a window picture of the Picture-in-Picture feature whether or not it is equipped with an S VIDEO OUTPUT jack, it is necessary to connect input signals through the VIDEO jack of the VIDEO INPUT 1 jacks as well.

About S Video Input

Video input and output signals may be separated into Y (luminance or brightness) and C (chroma or color) signals. Usually these two signals are combined in a VCR and sent as one signal to a projector. Separation of the Y and C signals prevents them from interfering with one another, thereby improving picture (especially in color) quality. This projection TV is equipped with an S video input jack through which these separated signals can be input directly.

Connecting Camcorders

To play back recorded tapes

VIDEO 2 IN

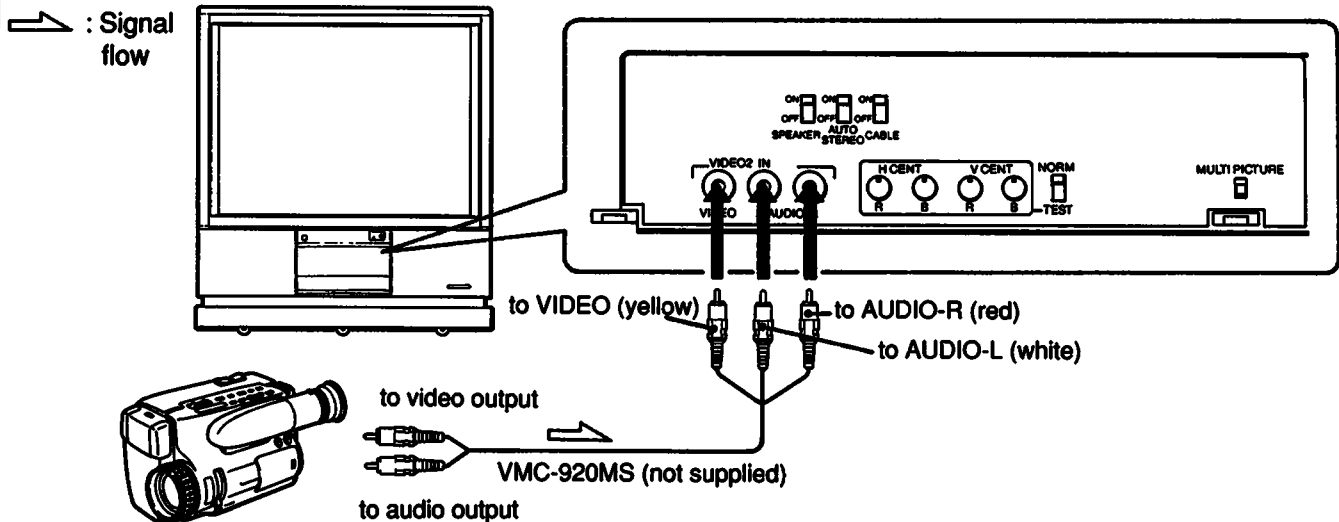

Connecting Two VCRs for Tape Editing

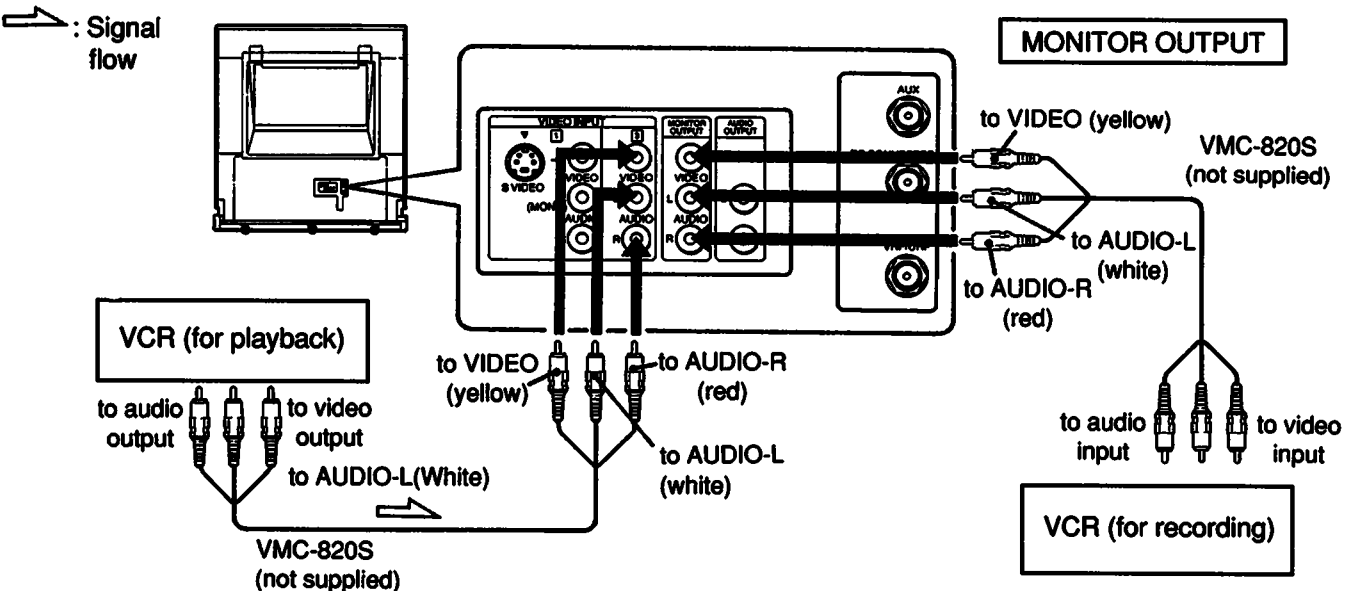

To Operate

- 1 Press the desired mode select button or press the TV/VIDEO button so that the desired video source display appears. The VIDEO lamp will light up.
 - 2 Set the playback VCR to the playback mode and set the recording VCR to the recording mode.
- To edit the tape, connect the playback VCR to the VIDEO 2 or VIDEO 3 INPUT jacks.

Every time you press the TV/VIDEO button, the display will change as follows:

VIDEO 1 → VIDEO 2 → VIDEO 3 → TV channel

The channel number buttons on the remote commander and the CHANNEL scan buttons will not function while the VIDEO lamp is lit.

Connecting Audio Equipment

To Monitor TV Sound with a Stereo System

➤ : Signal flow

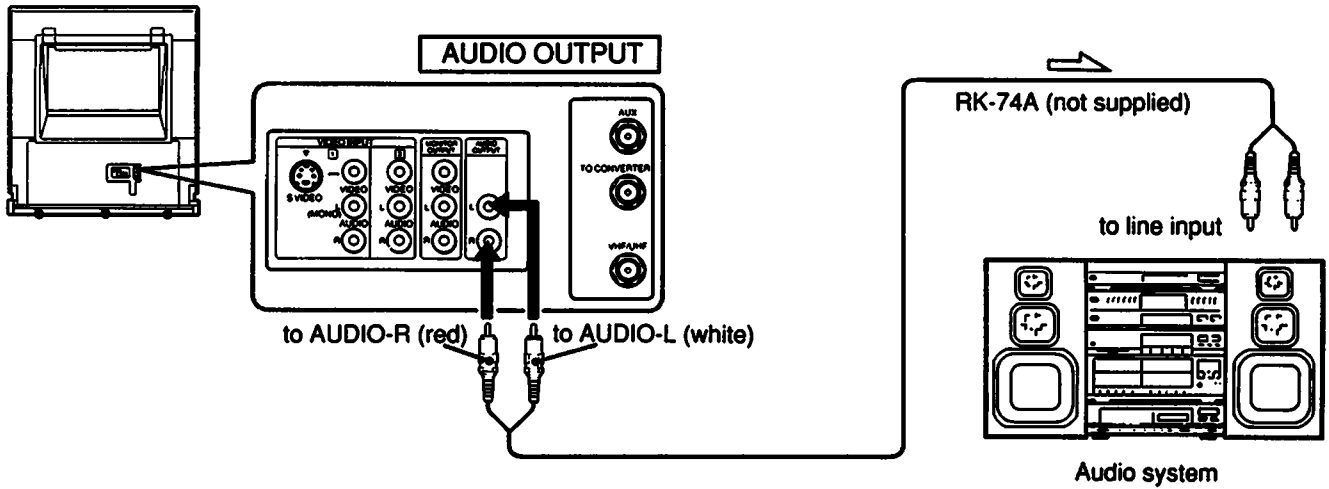

After connecting, you will be able to adjust sound volume from the stereo speakers with the volume buttons on the projection TV or remote commander.

To monitor TV sound only from a stereo system, set the SPEAKER selector on the front panel to OFF.

When the SPEAKER selector is set to ON, adjust the volume from the speakers with the stereo amplifier.

Viewing Area

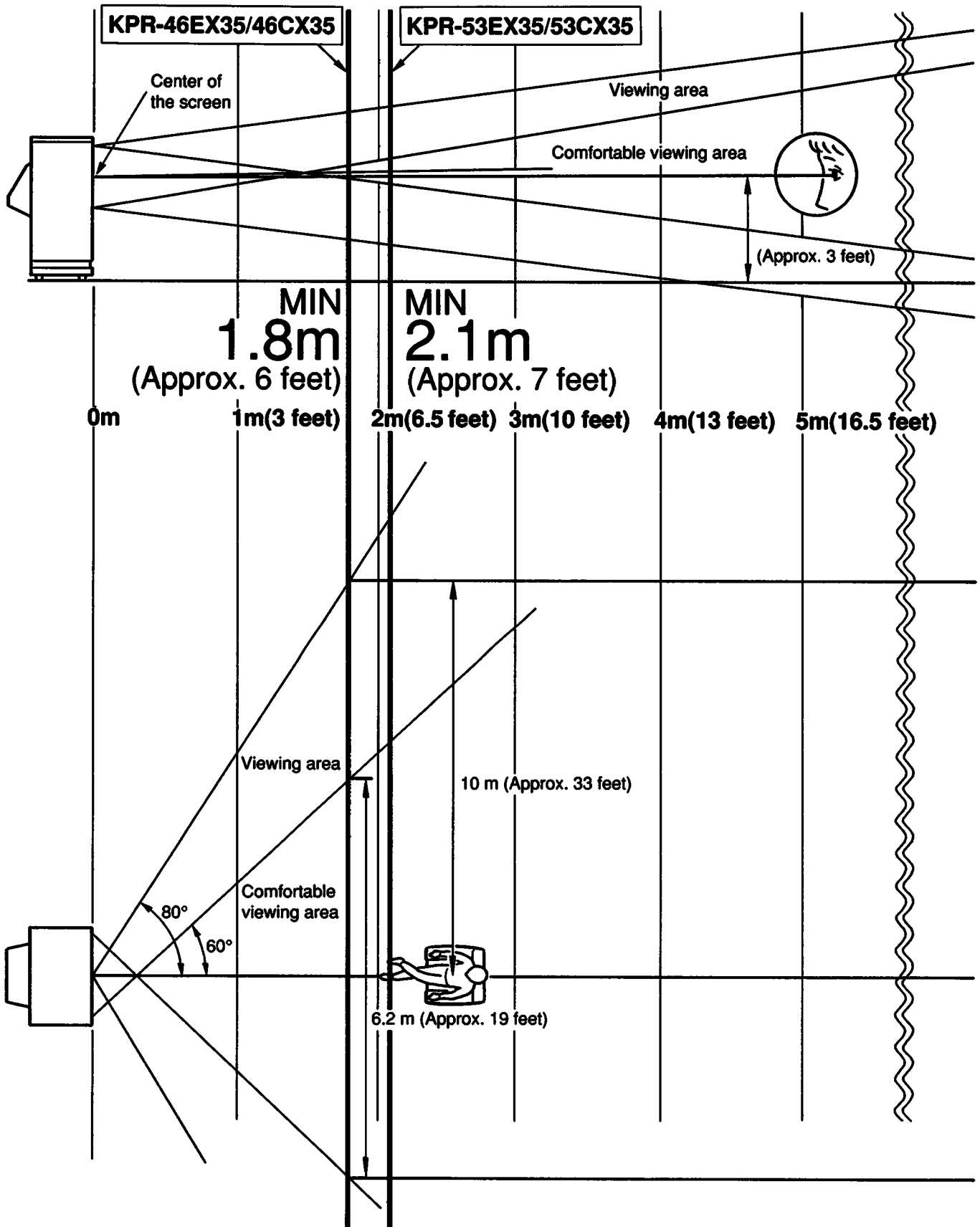

Viewing Area

Specifications

Structure	Screen and projector, rear projection type
Projection system	3 picture tubes, 3 lenses, horizontal in-line system
Picture tube	5.5 inch high-brightness monochrome tubes, with optical coupling and cooling system
Projection lenses	High performance, large-diameter hybrid lens F 1.0
Screen material	Acrylic plastic lenticular, Polycarbonate plastic Fresnel, Acrylic plastic filter (KPR-53CX35 only)
Resolution	700 lines
Optimal viewing area	Within approx. 80 degrees from center

Projected picture size (measured diagonally)

	Picture size (in inches)
KPR-53CX35	53
KPR-53EX35	53
KPR-46CX35	46
KPR-46EX35	46

Screen brightness

	foot-Lamberts
KPR-53CX35	250
KPR-53EX35	370
KPR-46CX35	450
KPR-46EX35	450

Television system	American TV standards
Channel coverage	VHF: 2 – 13 UHF: 14 – 69 CATV: 1 – 125
Antenna	75-ohm external antenna terminal for VHF/UHF/CATV
Inputs	VIDEO 1, 2, 3 INPUT (phono jacks) Video: 1Vp-p, 75 ohms unbalanced, sync negative Audio: 460 mVrms (100% modulation, 47 kilohms) VIDEO 1 S VIDEO INPUT (4-pin mini DIN) Y: 1 Vp-p, 75 ohms unbalanced, sync negative C: 0.286 Vp-p (Burst signal), 75 ohms 75-ohm external antenna terminal for VHF/UHF/CATV AUX 75-ohm auxiliary antenna terminal

Outputs	MONITOR OUTPUT (phono jacks) Video: 1 Vp-p, 75 ohms unbalanced, sync negative Audio: 460 mVrms (100% modulation, 1 kilohm) AUDIO OUTPUT (phono jacks) 460 mVrms (variable) (100% modulation, 1 kilohm) TO CONVERTER terminal
Speaker	Two-way coaxial speaker system Woofer 20 cm (8 inches) dia. Tweeter 7.6 cm (3 inches) dia.
Power requirements	120 V AC, 60 Hz

Power consumption

	max.	avg.	standby mode
KPR-53CX35	290 W	175 W	3 W
KPR-53EX35			
KPR-46CX35	290 W	175 W	
KPR-46EX35			

	Dimensions (w/h/d)	Weight
KPR-53CX35	1257 x 1399 x 889* mm (49½ x 55½ x 35* in.)	145 kg (319 lbs 11 oz)
KPR-53EX35	1166 x 1370 x 882* mm (46 x 54 x 34¾* in.)	136 kg (299 lbs 14 oz)
KPR-46CX35	1134 x 1319 x 748 mm (44¾ x 52 x 29½ in.)	122 kg (269 lbs 17 oz)
KPR-46EX35	1056 x 1307 x 744 mm (41½ x 51½ x 29½ in.)	114 kg (251 lbs 6 oz)

* Depth when the mirror cover is installed inside the cabinet:
KPR-53CX35 – 677 mm (26½ in.)
KPR-53EX35 – 670 mm (26½ in.)



Supplied accessories	Remote Commander RM-Y110 (1) with 2 size AA EVEREADY batteries. Mini Commander RM-KIT (1) with 1 lithium battery CR2025 Antenna connector (1)
Optional accessories	UV mixer EAC-66 Connecting cable VMC-810/820S YC-15V/30V

Design and specifications are subject to change without notice.

Troubleshooting

Disturbances in picture and sound can often be eliminated by checking the symptoms and following the suggestions listed here.

	SYMPTOM	CHECK AND ADJUST
GENERAL	Poor or no picture (screen not lit), good sound	<ul style="list-style-type: none"> • Adjust PICTURE. • Adjust BRIGHT. • Check antenna/cable connections. • Adjust the registration (see page 13).
	Good picture, no sound	<ul style="list-style-type: none"> • Press VOLUME +. • Release MUTING on the remote commander. • Check that the MTS button is set correctly. • Check that the TV/VIDEO or input select button is set correctly. • Set the SPEAKER switch to ON.
	No picture (screen not lit), no sound	<ul style="list-style-type: none"> • Is POWER switched on? • Plug the projection TV into a wall outlet. • Check that the TV/VIDEO button is set correctly.
	No color	<ul style="list-style-type: none"> • Is it a color program? • Adjust COLOR.
	Snow and noise only	<ul style="list-style-type: none"> • Is it an active or correct channel? • Check the CABLE selector setting. • Check the ANT/AUX button setting. • Check antenna/cable connections.
	Learning function on the remote commander does not work.	<ul style="list-style-type: none"> • Check the USE/LEARN selector setting. • Check that the remote commanders are positioned properly. • Check whether the batteries are exhausted. • If there is fluorescent lighting nearby, move the remote commanders away from it.

	SYMPTOM	CHECK AND ADJUST
GENERAL	 Dotted lines or stripes	This is often caused by local interference. (e.g. cars, neon signs, hairdryers etc.) Adjust antenna for minimum interference.
	 Double images or ghosts	Reflections from nearby mountains or buildings often cause this problem. A highly directional outdoor antenna or a CATV cable may improve the picture.
	Remote control does not operate.	• Check the battery in the remote commander.
Try another channel. It could be station trouble.		
CONNECTED EQUIPMENT	No picture and/or sound for the connected equipment.	<ul style="list-style-type: none"> • Check that the TV/VIDEO button is set correctly. • Are the connections made firmly? • Is the power of the connected equipment turned on? • Is the connected equipment set correctly?

If the problem persists, contact your nearest service facility.